

## CR56 NSK

Cam followers

TYPE: Roller bearings, Stud type track rollers, With axial guidance, full complement bearing, outer ring has a cylindrical outside surface, type CR (NSK), inch size

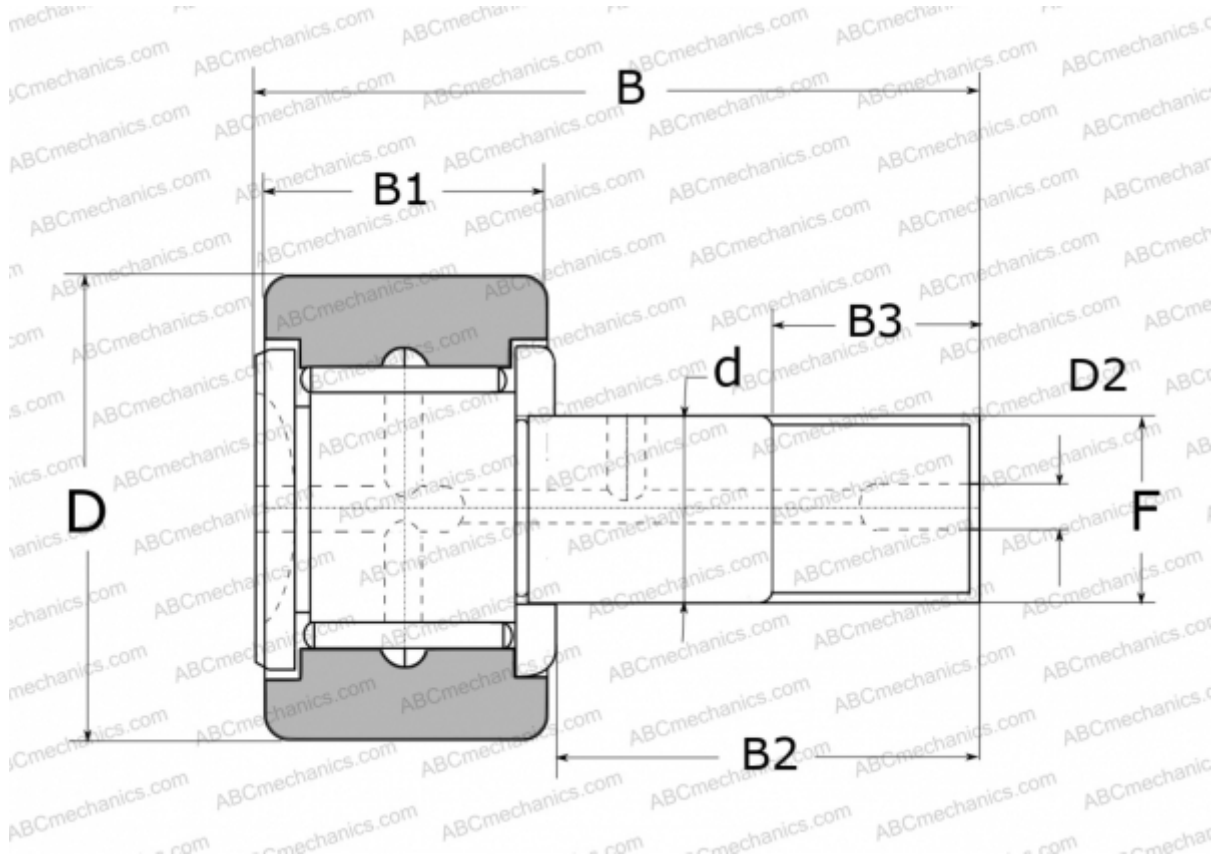

### Technical specification

#### DIMENSIONS, MM

d	34,925
D	88,900
D2	6,400
B	122,300
B1	50,800
B2	69,850
B3	34,900
F	1 3/8-12

**WEIGHT, KG** 2,900

**MANUFACTURER** [NSK](#)

#### REPLACES

CR-56