

## CRS10R NSK

Cam followers

TYPE: Roller bearings, Stud type track rollers, With axial guidance, full complement bearing, with seal, with thrust washer, outer ring has a spherical outside surface, type CRS..R (NSK), inch size

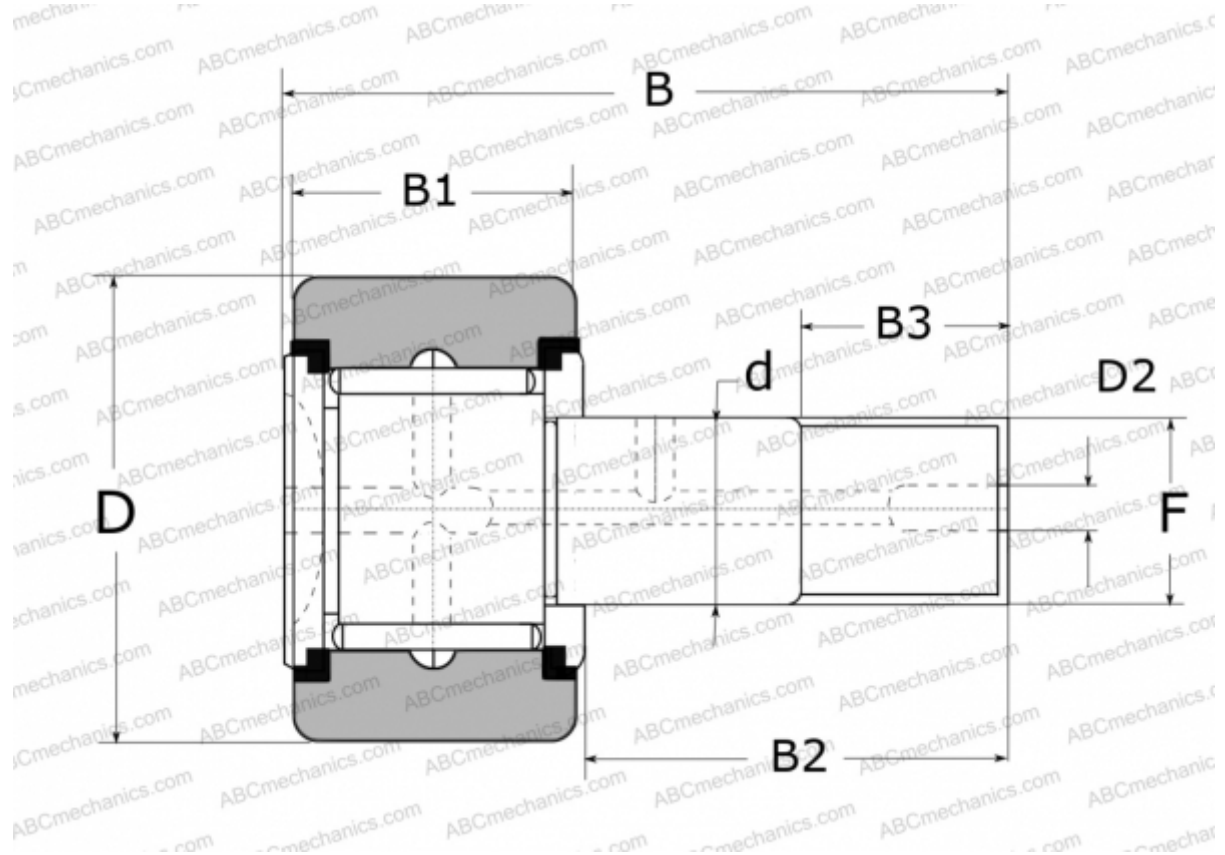

### Technical specification

#### DIMENSIONS, MM

d	6,350
D	15,875
D2	3,200
B	27,300
B1	10,310
B2	15,880
B3	7,900
F	1/4-28

**WEIGHT, KG** 0,019

**MANUFACTURER** [NSK](#)

#### REPLACES

CRS-10 R