

CRS14R NSK

Cam followers

TYPE: Roller bearings, Stud type track rollers, With axial guidance, full complement bearing, with seal, with thrust washer, outer ring has a spherical outside surface, type CRS..R (NSK), inch size

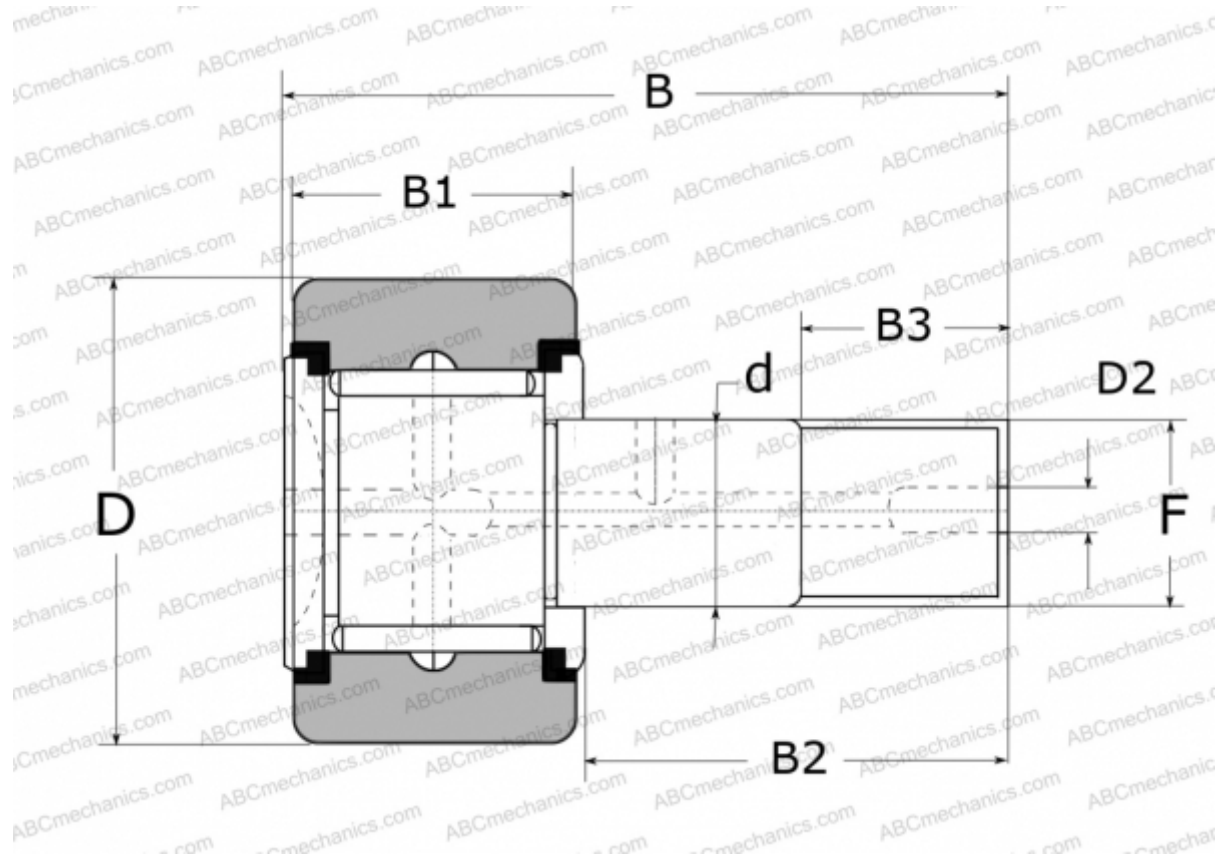

Technical specification

DIMENSIONS, MM

d	9,525
D	22,225
D2	4,800
B	36,100
B1	12,700
B2	22,220
B3	9,500
F	3/8-24

WEIGHT, KG 0,044

MANUFACTURER [NSK](#)

REPLACES

CRS-14 R