

CRS22R NSK

Cam followers

TYPE: Roller bearings, Stud type track rollers, With axial guidance, full complement bearing, with seal, with thrust washer, outer ring has a spherical outside surface, type CRS..R (NSK), inch size

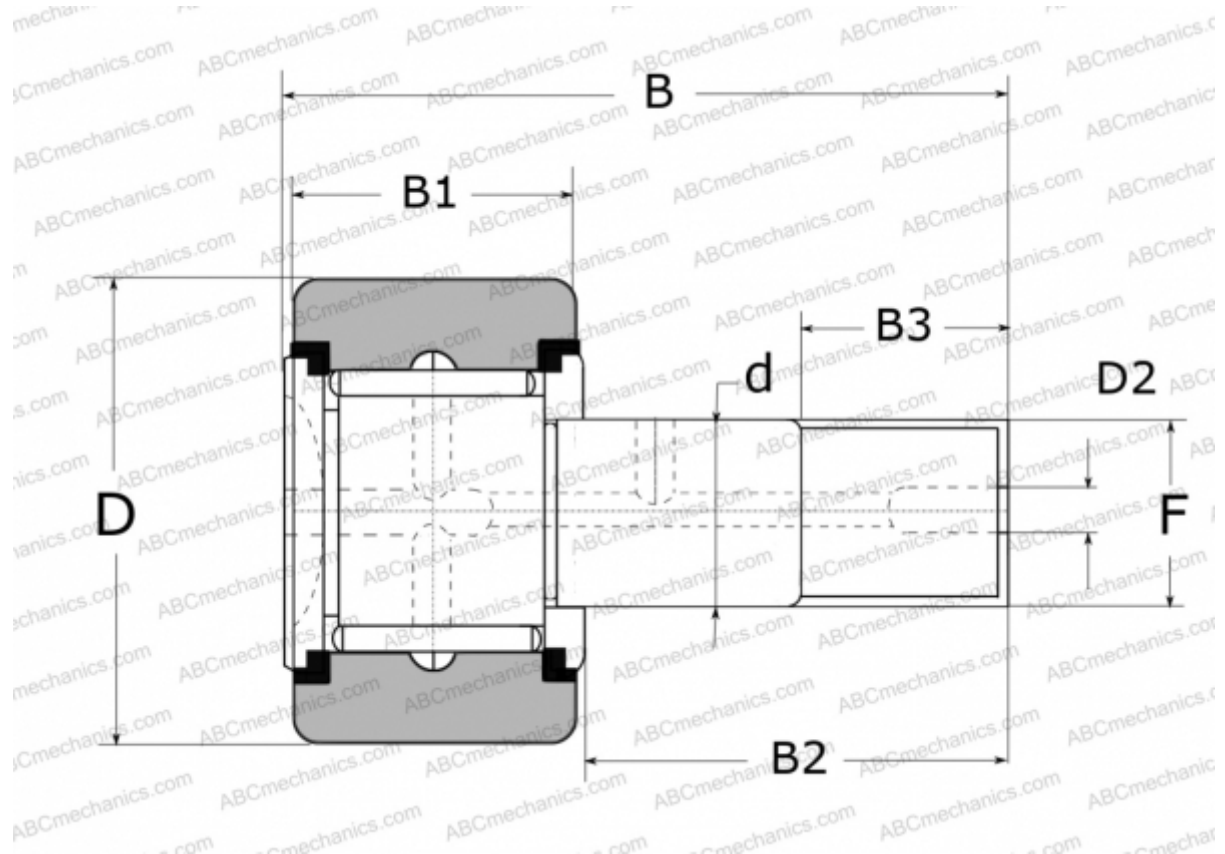

Technical specification

DIMENSIONS, MM

d	12,700
D	34,925
D2	4,800
B	52,200
B1	19,050
B2	31,750
B3	15,900
F	1/2-20

WEIGHT, KG 0,160

MANUFACTURER [NSK](#)

REPLACES

CRS-22 R