

CRS24R NSK

Cam followers

TYPE: Roller bearings, Stud type track rollers, With axial guidance, full complement bearing, with seal, with thrust washer, outer ring has a spherical outside surface, type CRS..R (NSK), inch size

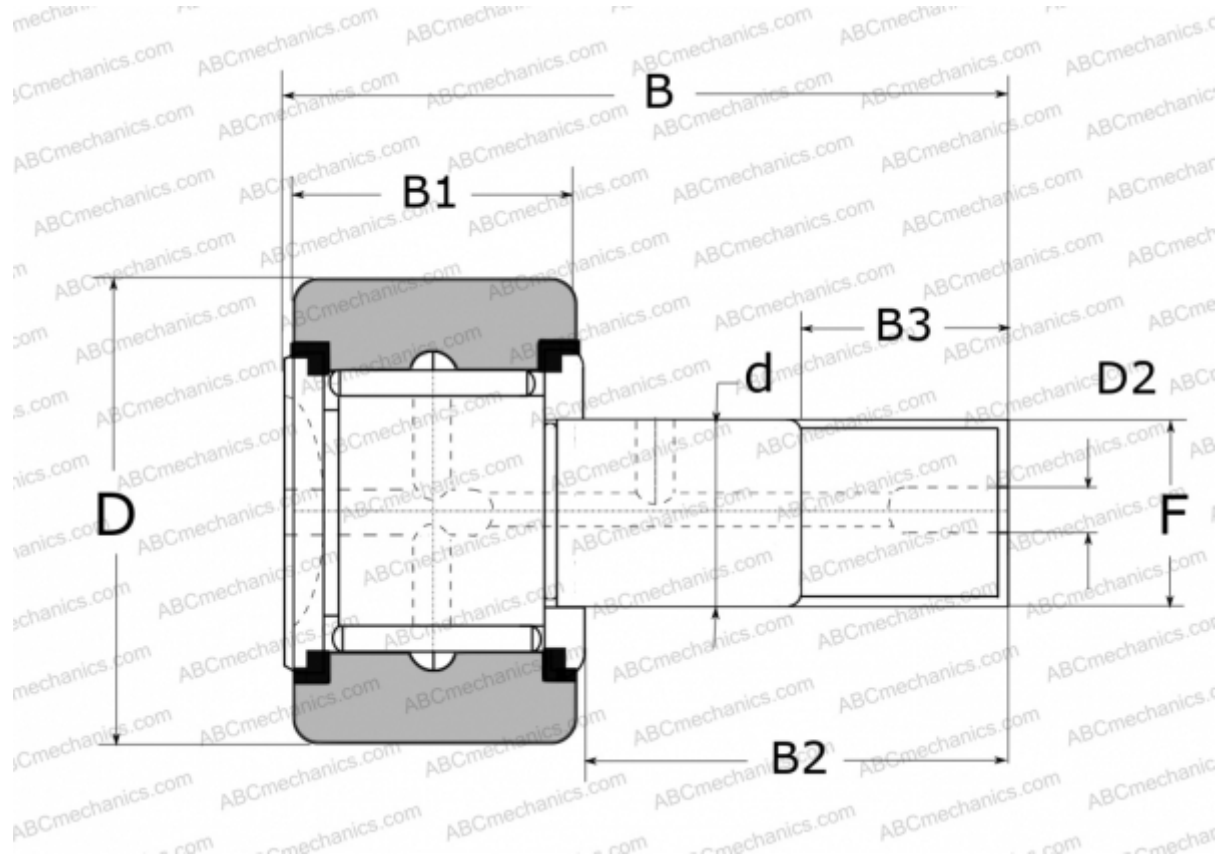

Technical specification

DIMENSIONS, MM

d	15,875
D	38,100
D2	4,800
B	61,600
B1	22,220
B2	38,100
B3	19,000
F	5/8-18

WEIGHT, KG 0,240

MANUFACTURER [NSK](#)

REPLACES

CRS-24 R