

CRS8 NSK

Cam followers

TYPE: Roller bearings, Stud type track rollers, With axial guidance, full complement bearing, with seal, with thrust washer, outer ring has a cylindrical outside surface, type CRS (NSK), inch size

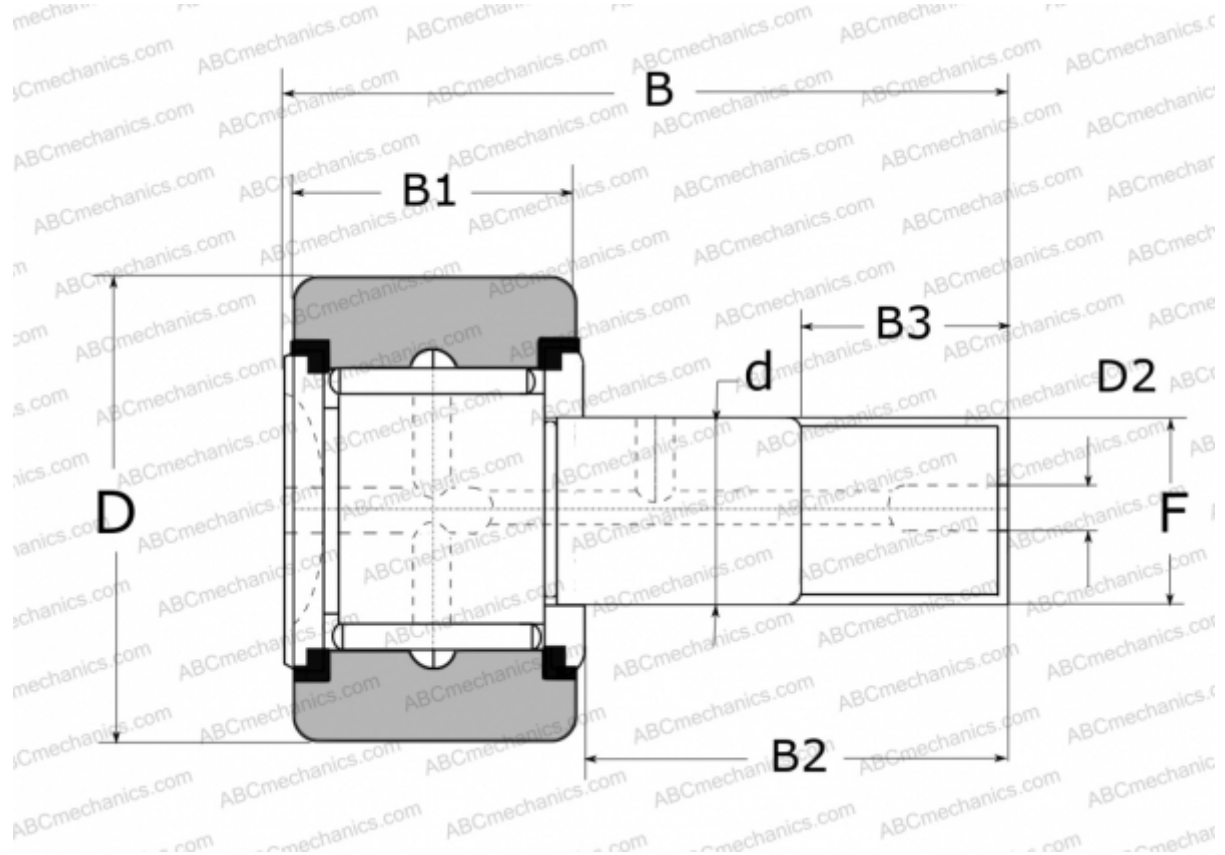

Technical specification

DIMENSIONS, MM

d	4,826
D	12,700
D2	3,200
B	22,800
B1	8,740
B2	12,700
B3	6,400
F	10-32

WEIGHT, KG 0,010

MANUFACTURER [NSK](#)

REPLACES

CRS-8