

CRS18 NSK

Cam followers

TYPE: Roller bearings, Stud type track rollers, With axial guidance, full complement bearing, with seal, with thrust washer, outer ring has a cylindrical outside surface, type CRS (NSK), inch size

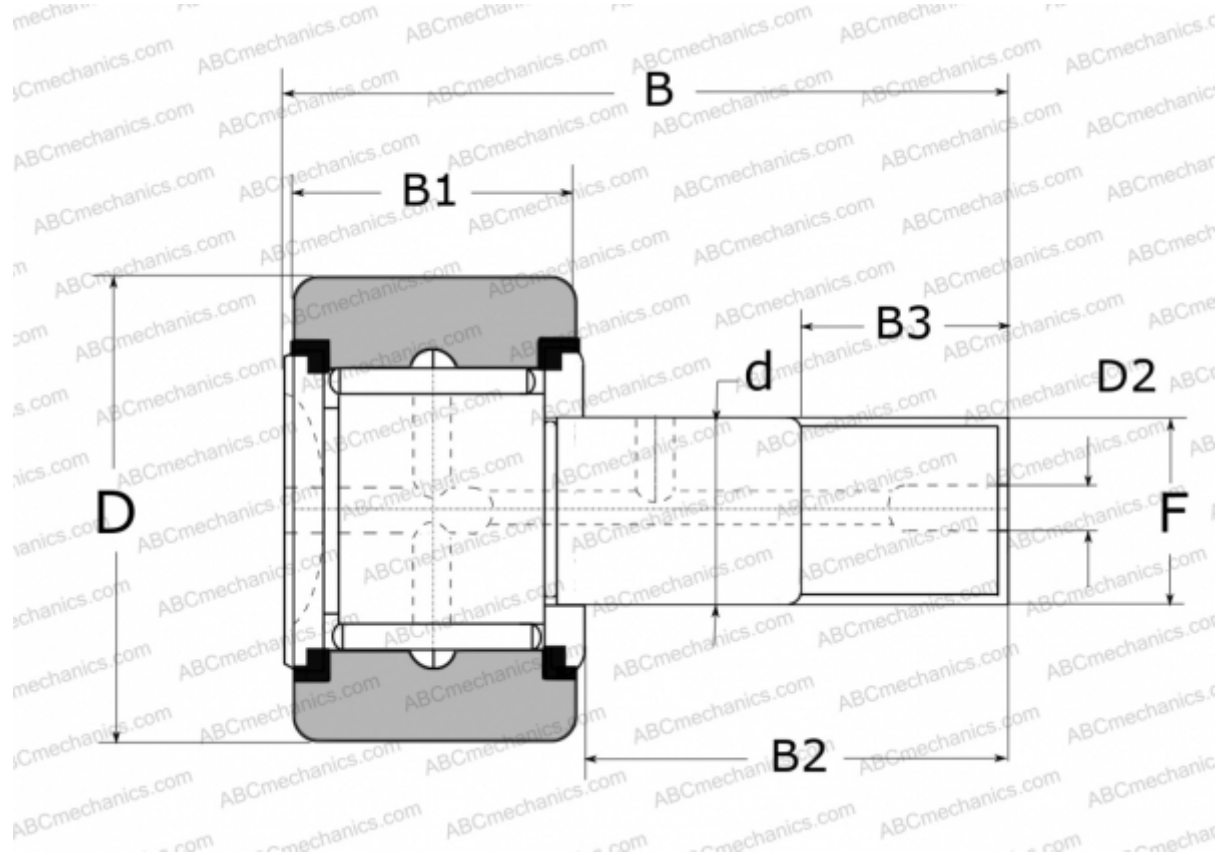

Technical specification

DIMENSIONS, MM

d	11,112
D	28,575
D2	4,800
B	42,400
B1	15,880
B2	25,400
B3	12,700
F	7/16-20

WEIGHT, KG 0,089

MANUFACTURER [NSK](#)

REPLACES

CRS-18