

## CRS30 NSK

Cam followers

TYPE: Roller bearings, Stud type track rollers, With axial guidance, full complement bearing, with seal, with thrust washer, outer ring has a cylindrical outside surface, type CRS (NSK), inch size

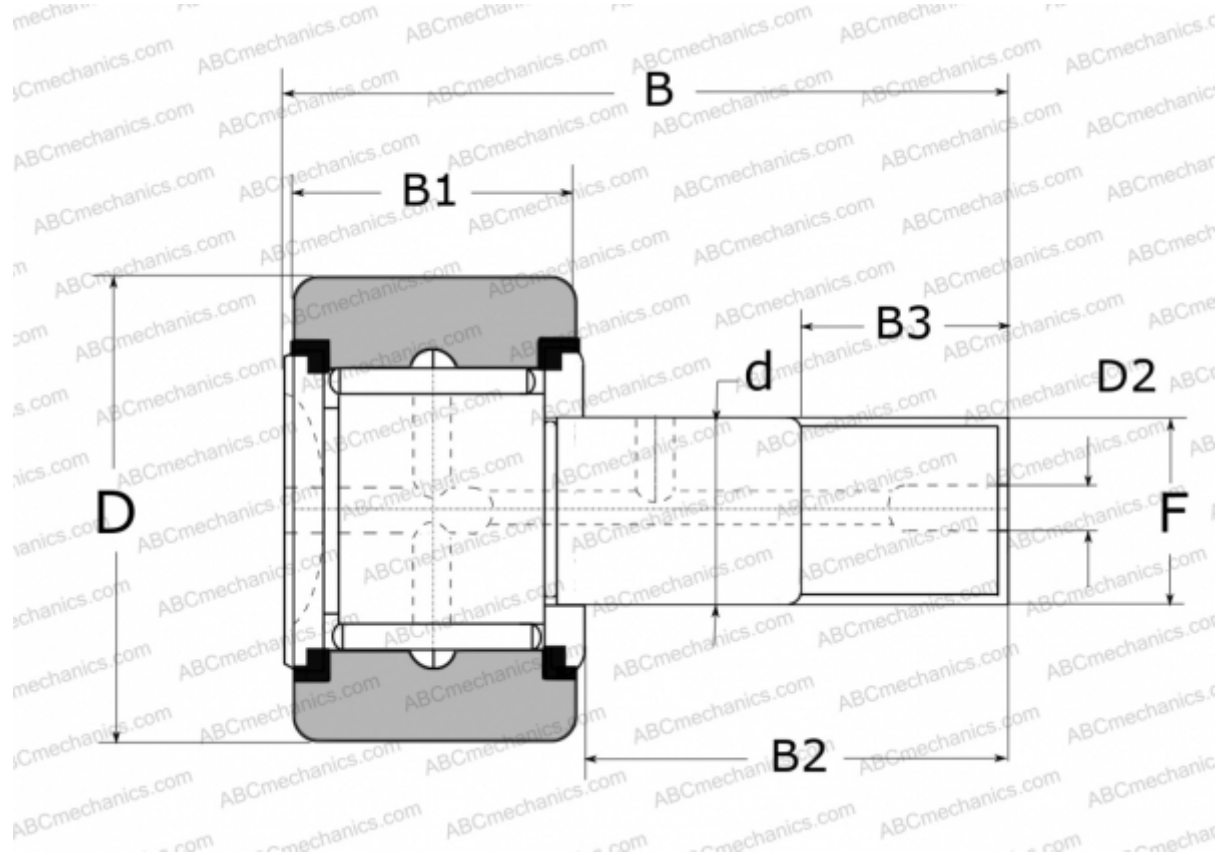

### Technical specification

#### DIMENSIONS, MM

d	19,050
D	47,625
D2	4,800
B	71,200
B1	25,400
B2	44,450
B3	22,200
F	3/4-16

**WEIGHT, KG** 0,430

**MANUFACTURER** [NSK](#)

#### REPLACES

CRS-30