

CRS48 NSK

Cam followers

TYPE: Roller bearings, Stud type track rollers, With axial guidance, full complement bearing, with seal, with thrust washer, outer ring has a cylindrical outside surface, type CRS (NSK), inch size

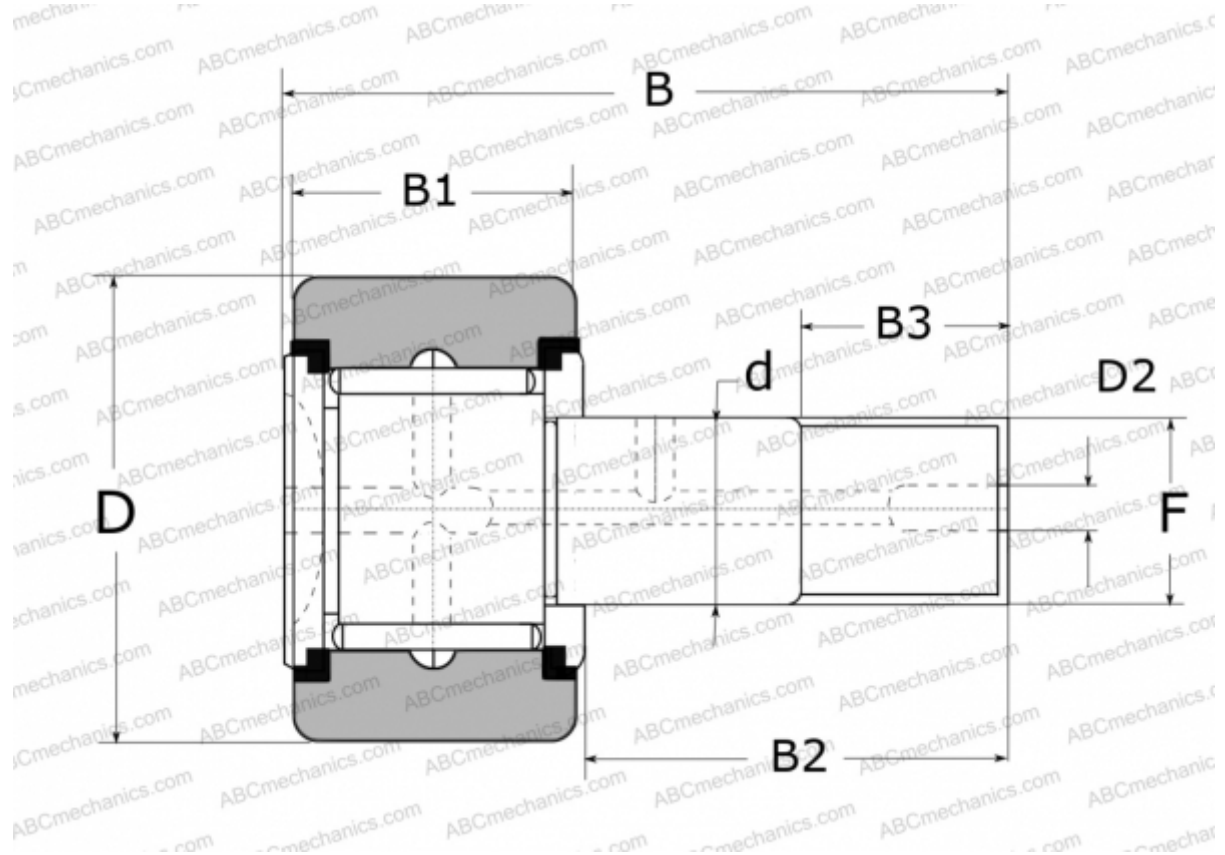

Technical specification

DIMENSIONS, MM

d	31,750
D	76,200
D2	6,400
B	109,600
B1	44,450
B2	63,500
B3	31,800
F	1 1/4-12

WEIGHT, KG 1,900

MANUFACTURER [NSK](#)

REPLACES

CRS-48