

66225/66462D TIMKEN

Tapered roller bearings

TYPE: Roller bearings, Tapered, Double row, Type TDO, double outer ring

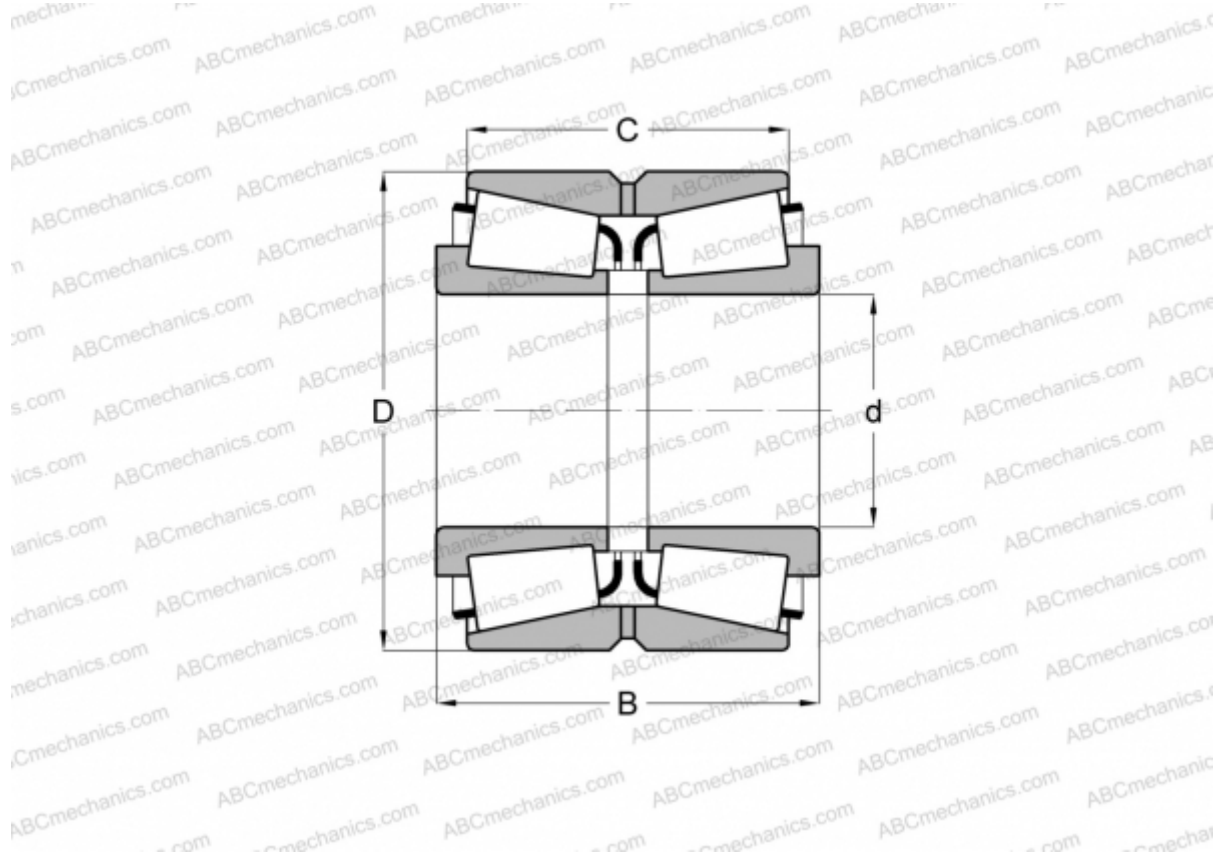

Technical specification

DIMENSIONS, MM

d	57,150
D	117,475
B	73,025
C	53,975

WEIGHT, KG 3,350

MANUFACTURER [TIMKEN](#)