

9378/9320D TIMKEN

Tapered roller bearings

TYPE: Roller bearings, Tapered, Double row, Type TDO, double outer ring

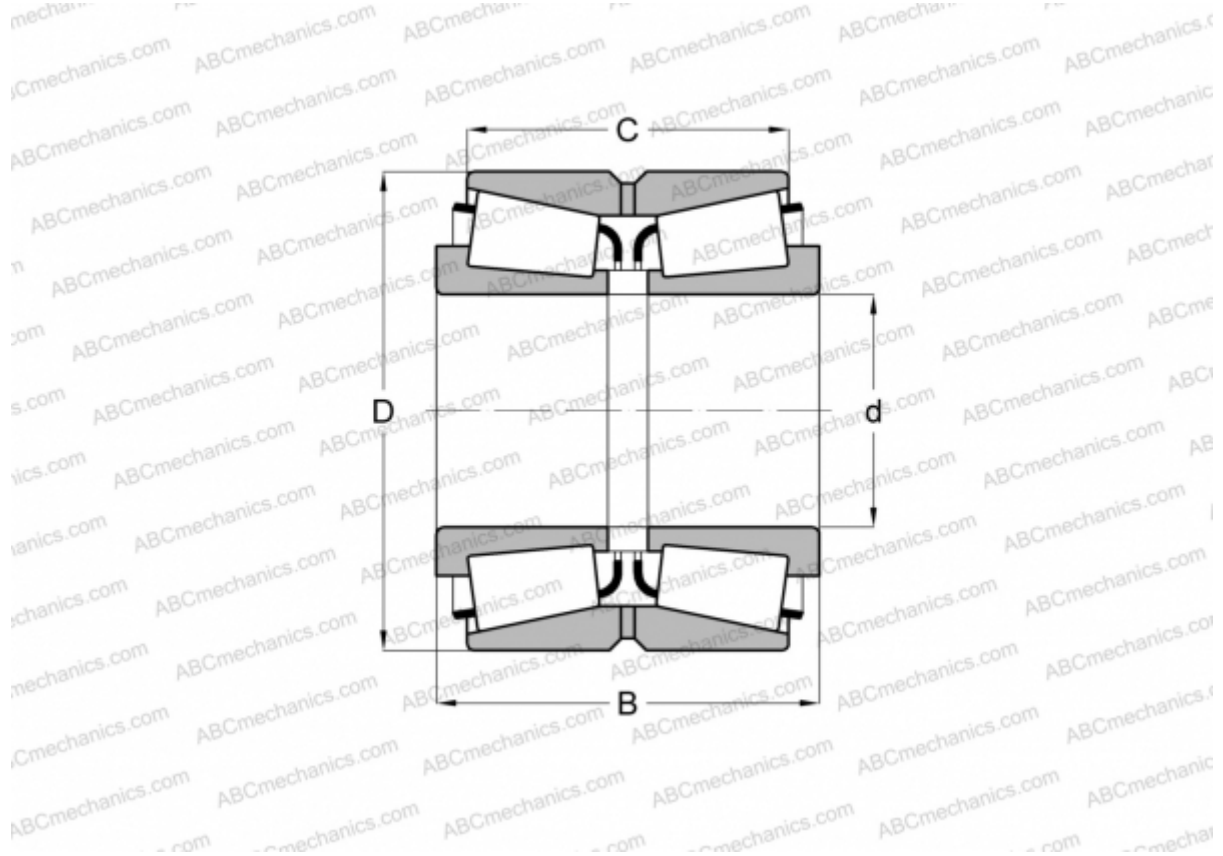

Technical specification

DIMENSIONS, MM

d	76,200
D	177,800
B	115,888
C	74,612

WEIGHT, KG 12,680

MANUFACTURER [TIMKEN](#)