

LL686947/LL686910D TIMKEN

Tapered roller bearings

TYPE: Roller bearings, Tapered, Double row, Type TDO, double outer ring

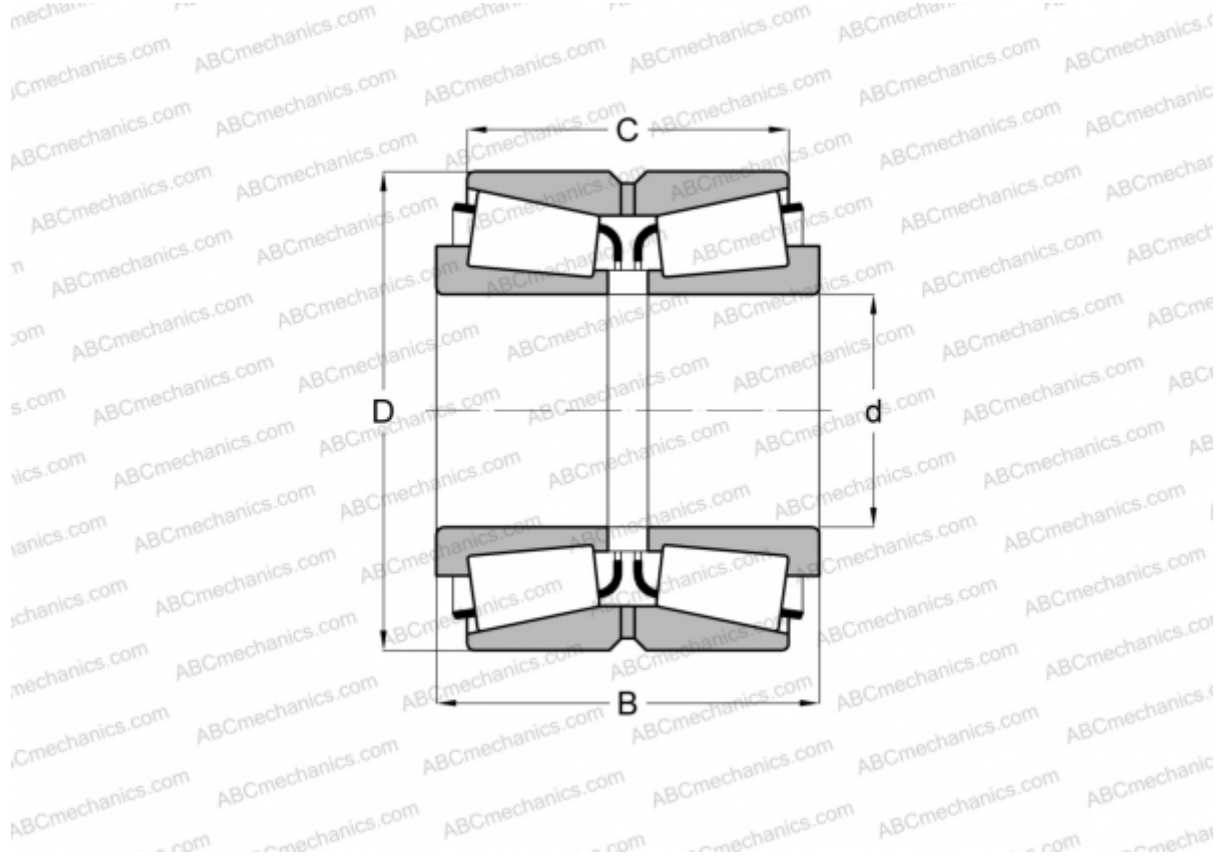

Technical specification

DIMENSIONS, MM

d	914,400
D	1066,800
B	139,700
C	101,600

WEIGHT, KG 198,260

MANUFACTURER [TIMKEN](#)