

## LM742749D/LM742714 TIMKEN

Tapered roller bearings

TYPE: Roller bearings, Tapered, Double row, Type TDI, double inner ring

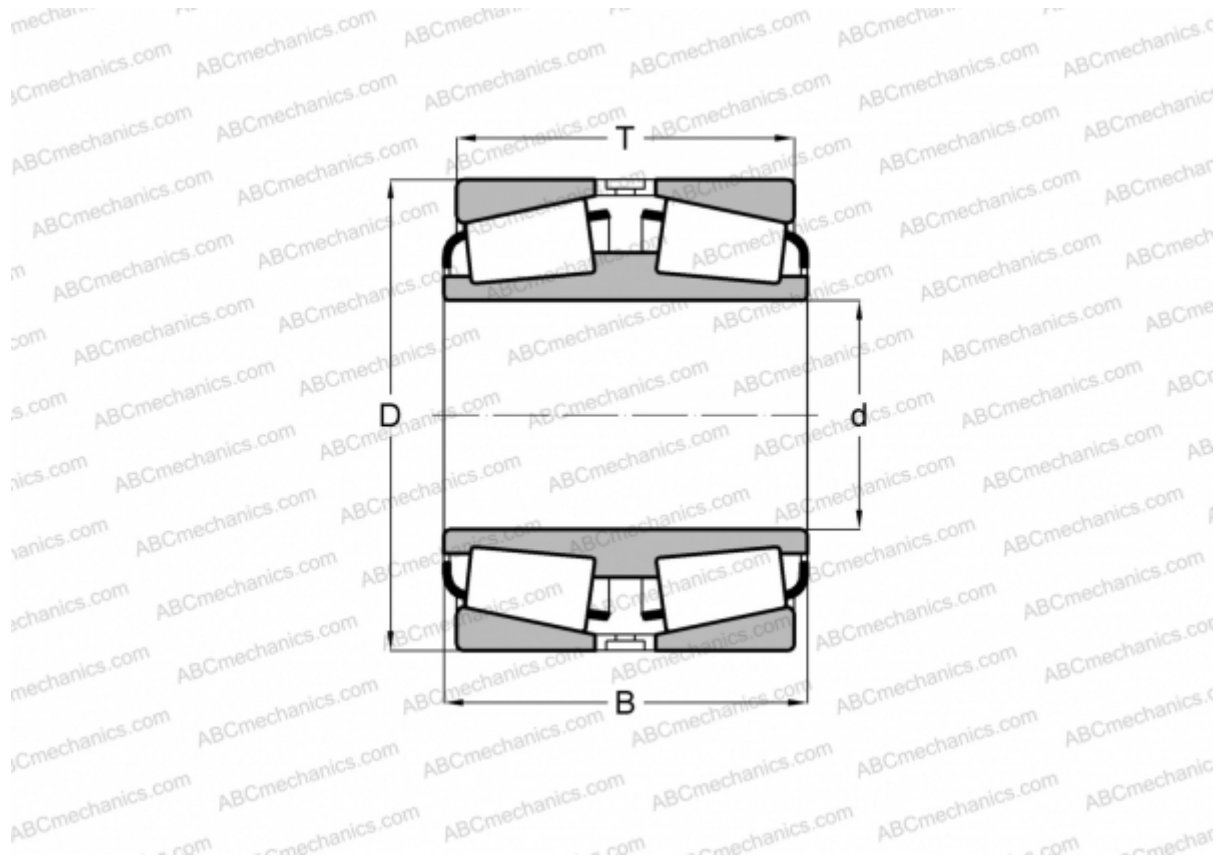

### Technical specification

#### DIMENSIONS, MM

d	215,900
D	288,925
B	85,725
T	85,725

**WEIGHT, KG** 15,880

**MANUFACTURER** [TIMKEN](#)