

HM252343D/HM252315 TIMKEN

Tapered roller bearings

TYPE: Roller bearings, Tapered, Double row, Type TDI, double inner ring

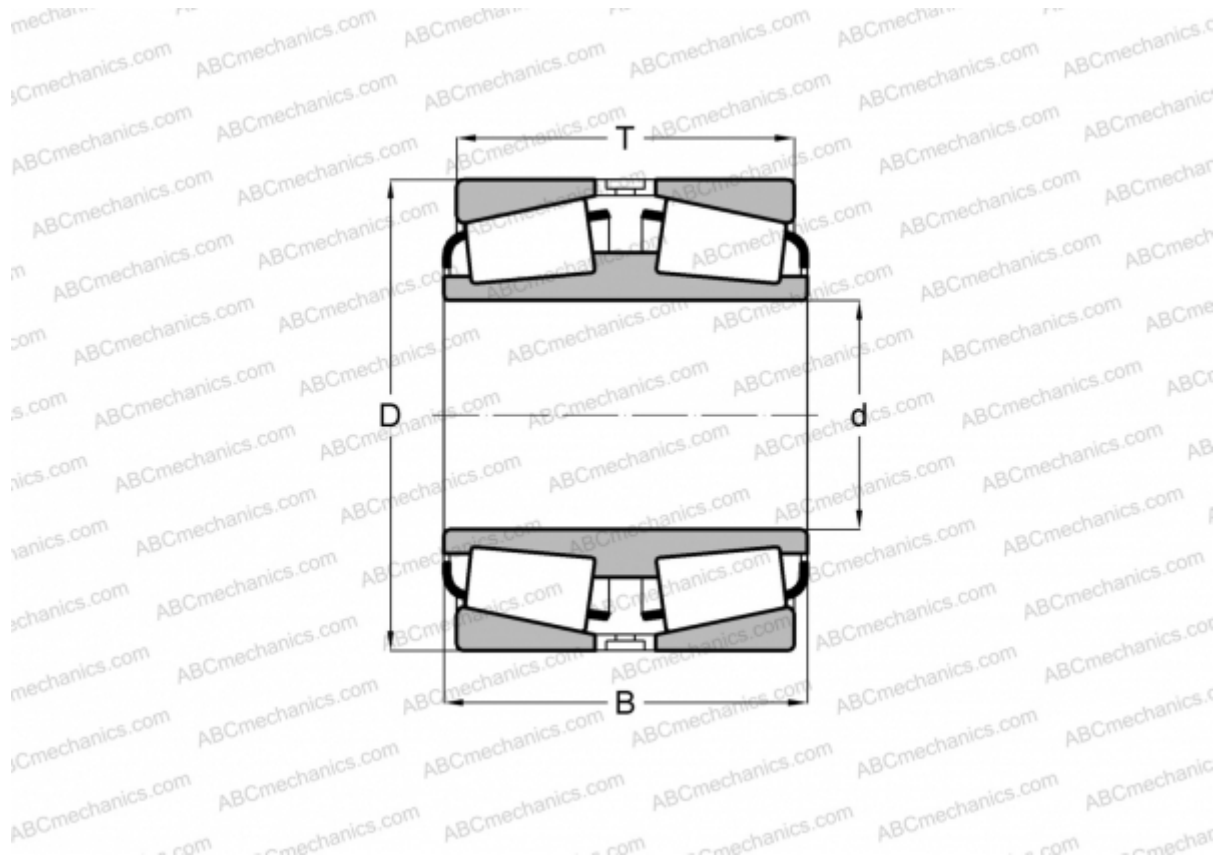

Technical specification

DIMENSIONS, MM

d	254,000
D	431,724
B	139,700
T	145,258

WEIGHT, KG 82,790

MANUFACTURER [TIMKEN](#)