

LM258649D/LM258610 TIMKEN

Tapered roller bearings

TYPE: Roller bearings, Tapered, Double row, Type TDI, double inner ring

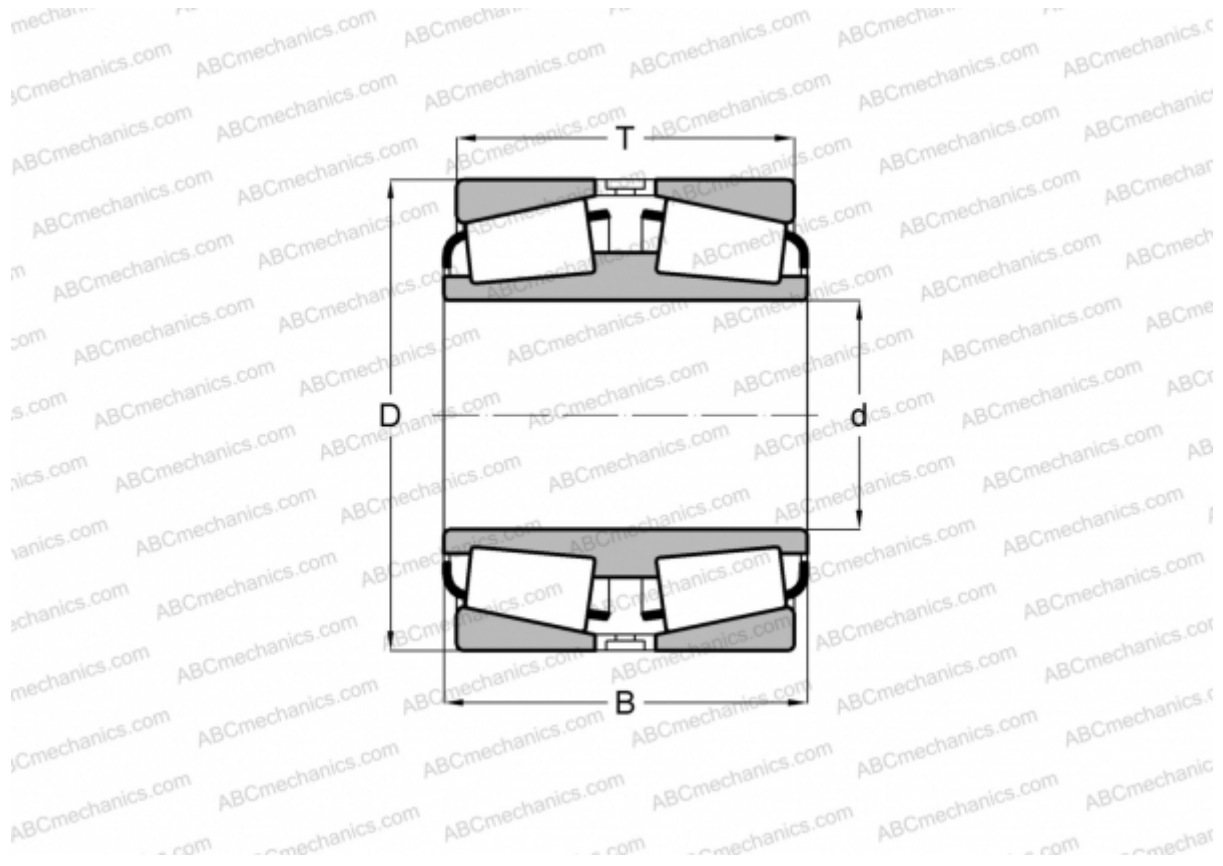

Technical specification

DIMENSIONS, MM

d	317,500
D	422,275
B	128,588
T	128,588

WEIGHT, KG 48,230

MANUFACTURER [TIMKEN](#)