

HM261049D/HM261010 TIMKEN

Tapered roller bearings

TYPE: Roller bearings, Tapered, Double row, Type TDI, double inner ring

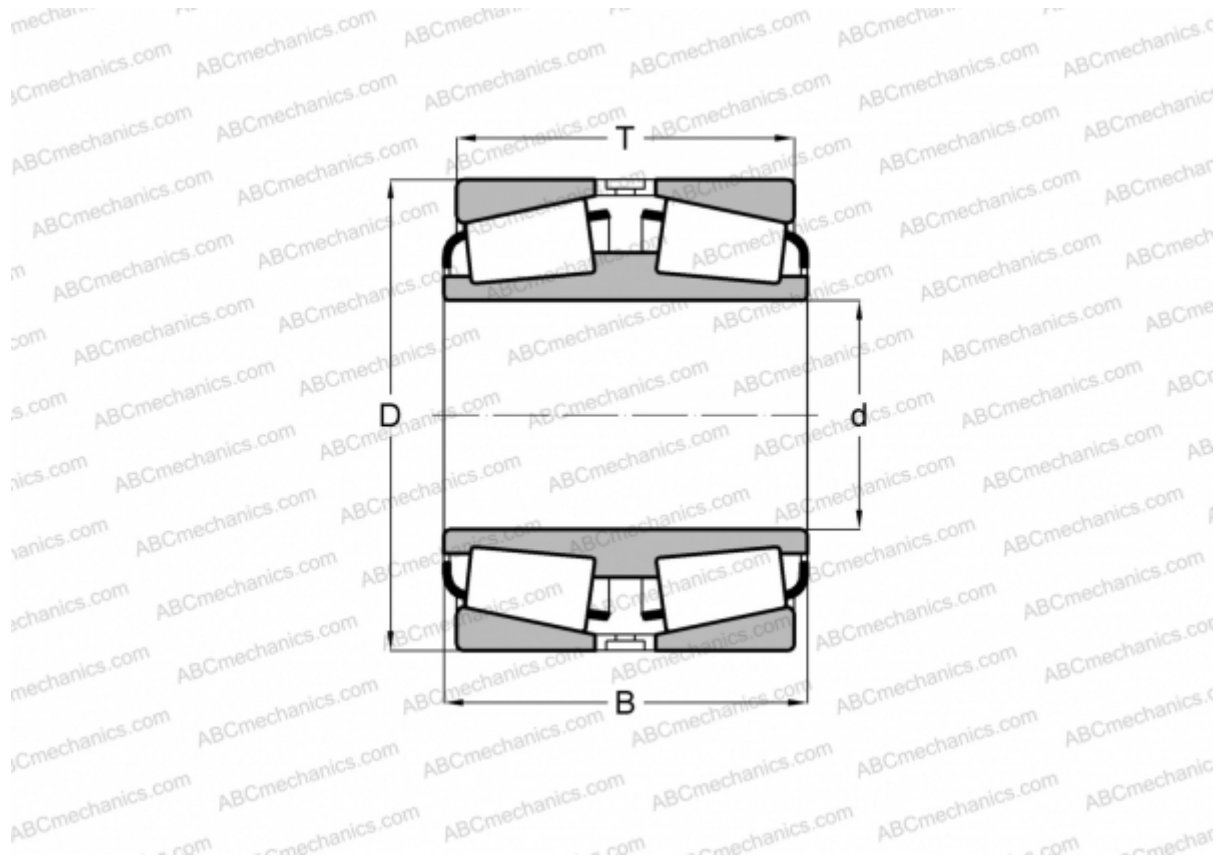

Technical specification

DIMENSIONS, MM

d	333,375
D	469,900
B	166,688
T	166,688

WEIGHT, KG 95,390

MANUFACTURER [TIMKEN](#)