

HM266449D/HM266410 TIMKEN

Tapered roller bearings

TYPE: Roller bearings, Tapered, Double row, Type TDI, double inner ring

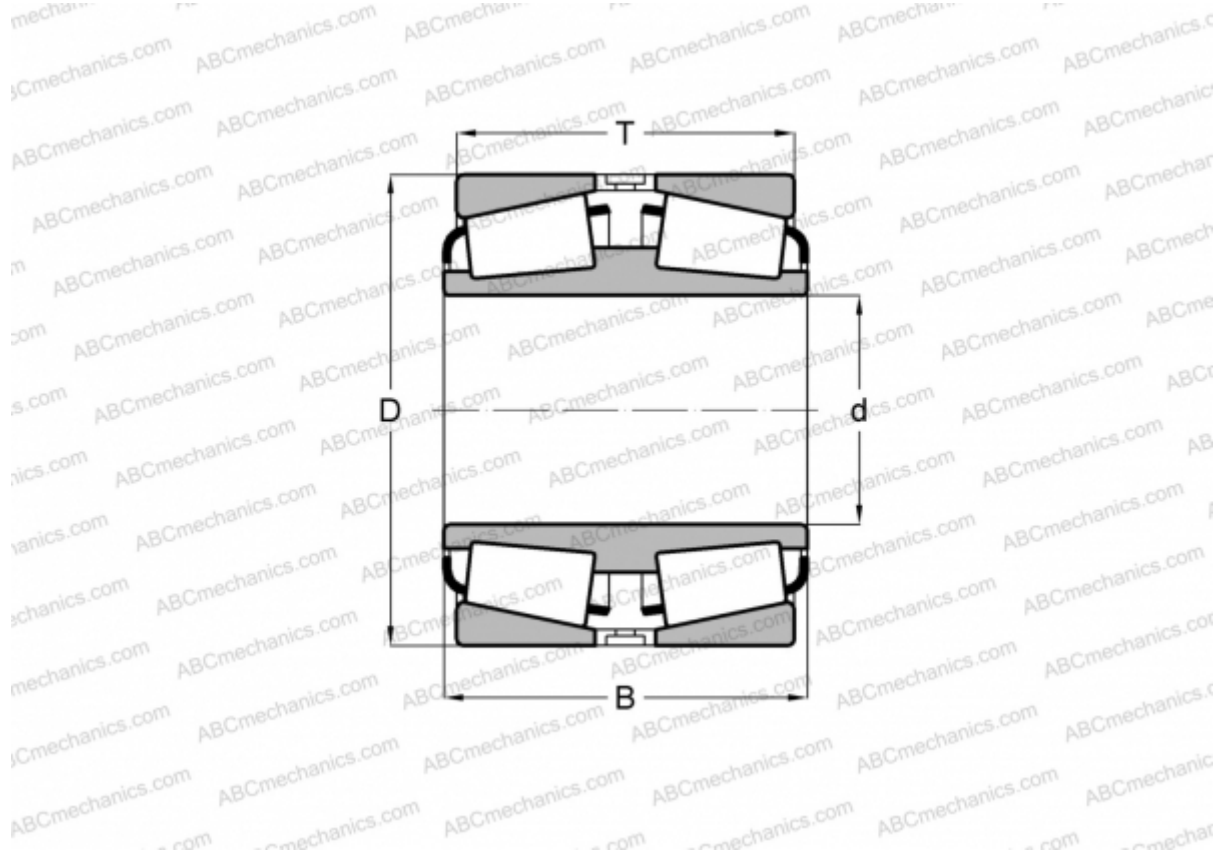

Technical specification

DIMENSIONS, MM

d	384,175
D	546,100
B	193,675
T	193,675

WEIGHT, KG 154,730

MANUFACTURER [TIMKEN](#)