

LM767745D/LM767710 TIMKEN

Tapered roller bearings

TYPE: Roller bearings, Tapered, Double row, Type TDI, double inner ring

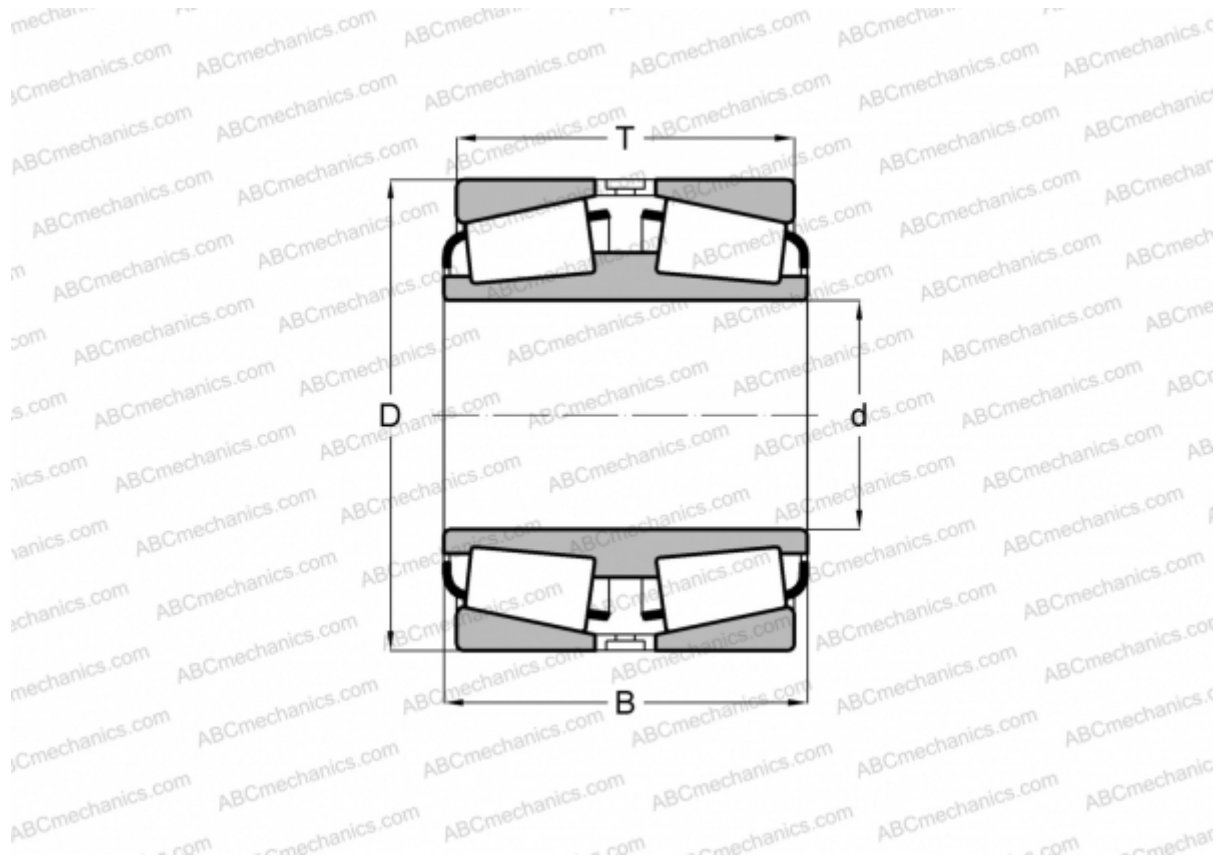

Technical specification

DIMENSIONS, MM

d	393,700
D	546,100
B	138,112
T	138,112

WEIGHT, KG 98,850

MANUFACTURER [TIMKEN](#)