

LM274449D/LM274410 TIMKEN

Tapered roller bearings

TYPE: Roller bearings, Tapered, Double row, Type TDI, double inner ring

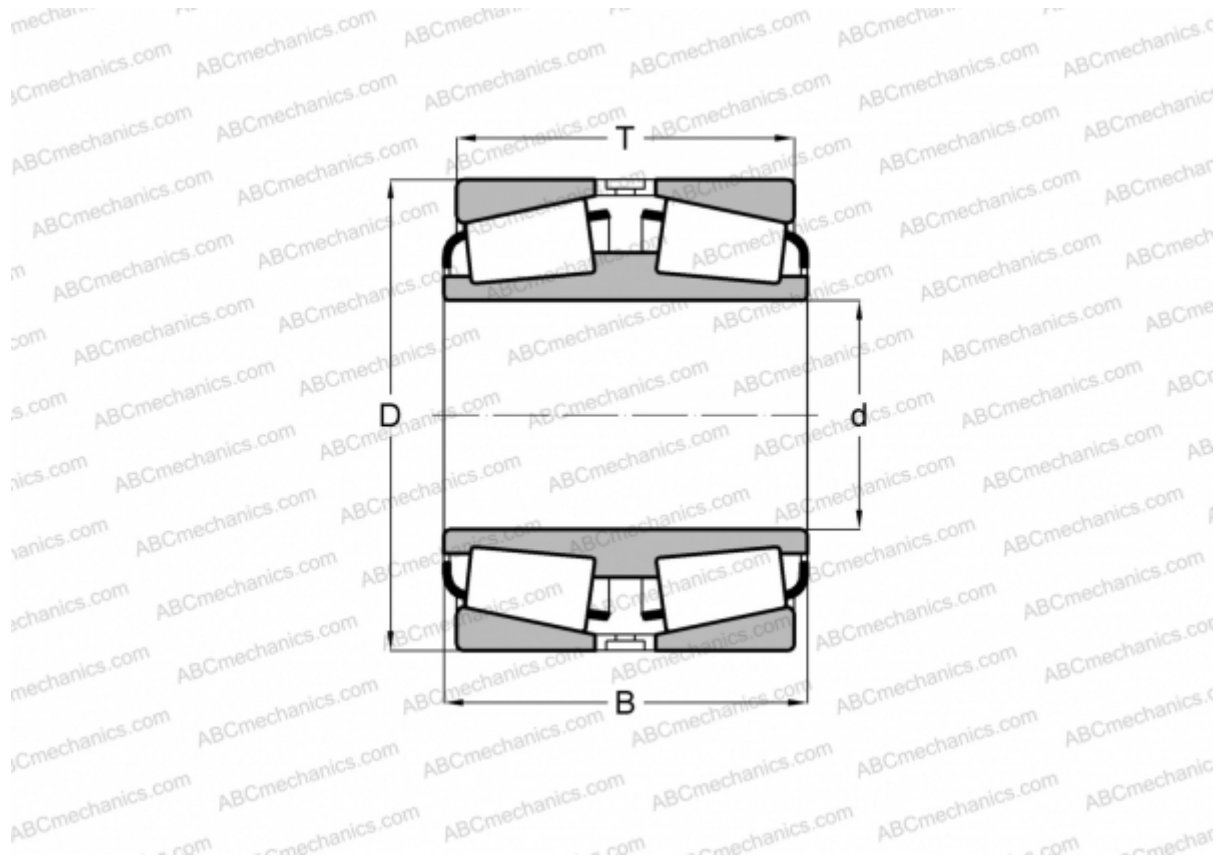

Technical specification

DIMENSIONS, MM

d	514,350
D	673,100
B	203,200
T	203,200

WEIGHT, KG 321,700

MANUFACTURER [TIMKEN](#)