

19146TD/19283 TIMKEN

Tapered roller bearings

TYPE: Roller bearings, Tapered, Double row, Type TDIIIT, double inner ring, tapered inner bore

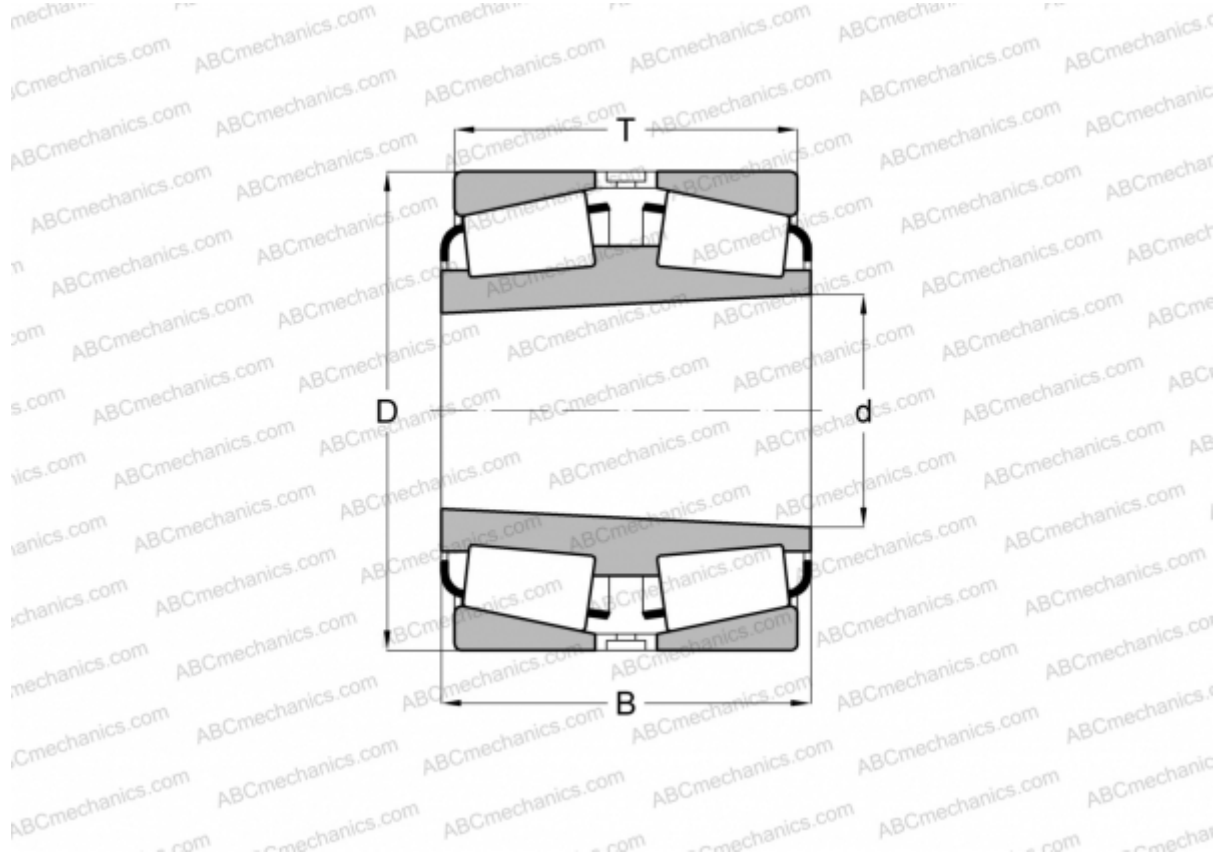

Technical specification

DIMENSIONS, MM

d	37,037
D	72,000
B	38,100
T	39,096

WEIGHT, KG 0,710

MANUFACTURER [TIMKEN](#)