

688TD/672 TIMKEN

Tapered roller bearings

TYPE: Roller bearings, Tapered, Double row, Type TDIIIT, double inner ring, tapered inner bore

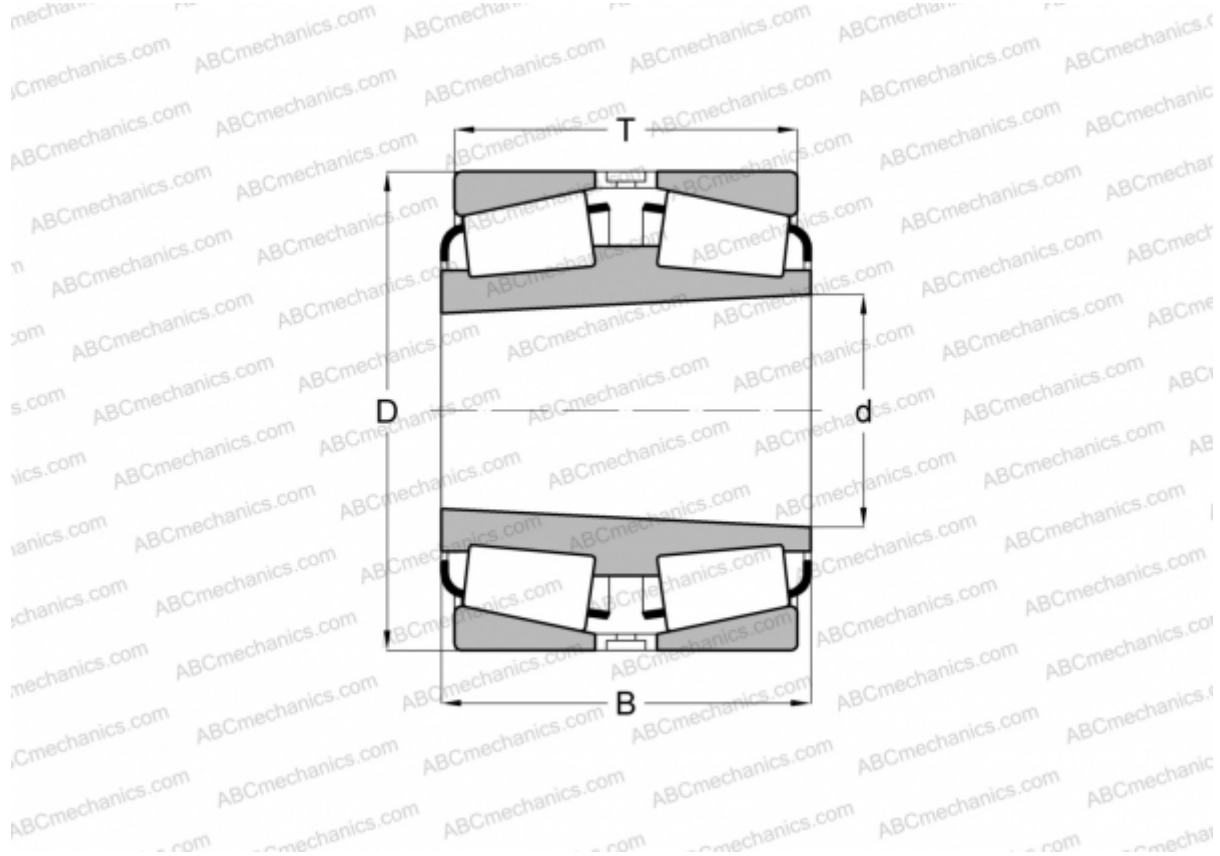

Technical specification

DIMENSIONS, MM

d	100,211
D	168,275
B	95,250
T	95,250

WEIGHT, KG 8,380

MANUFACTURER [TIMKEN](#)