

M252349TD/M252310 TIMKEN

Tapered roller bearings

TYPE: Roller bearings, Tapered, Double row, Type TDIIIT, double inner ring, tapered inner bore

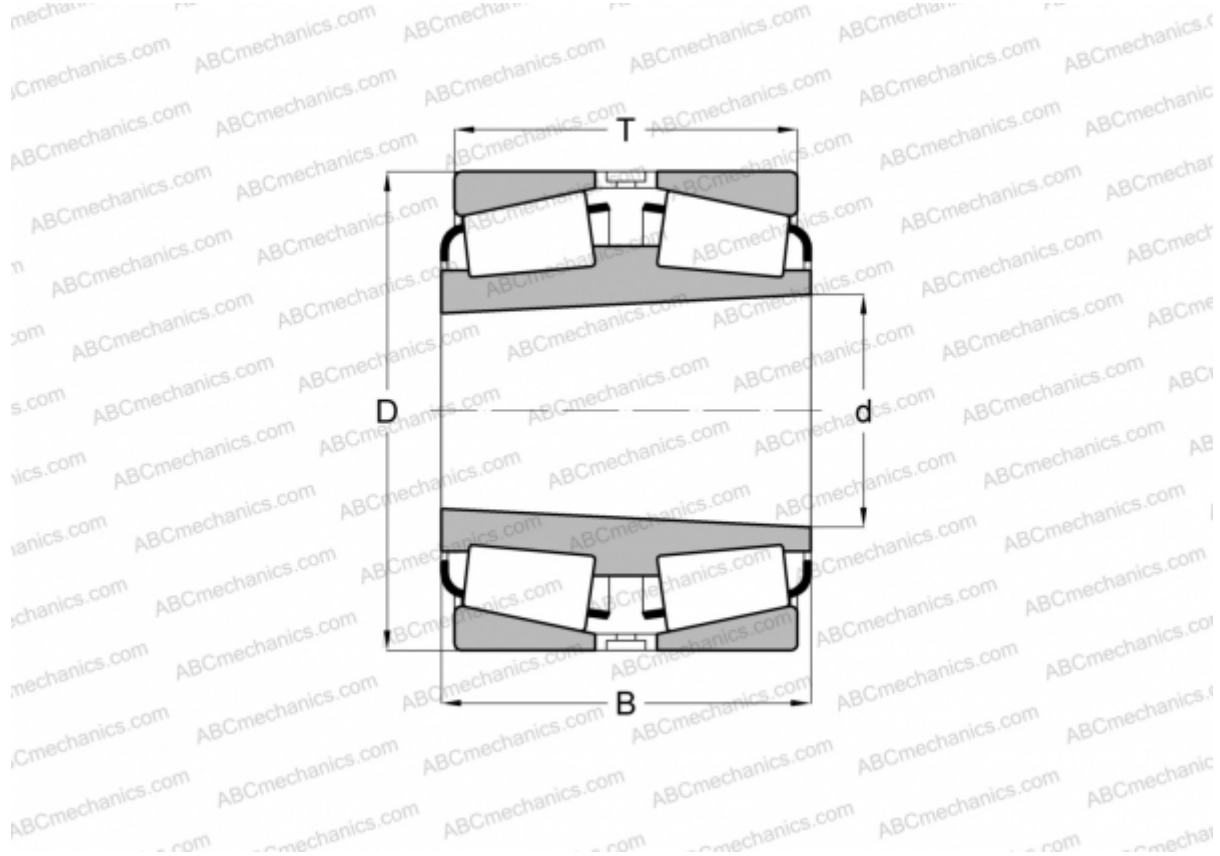

Technical specification

DIMENSIONS, MM

d	269,875
D	381,000
B	136,525
T	136,525

WEIGHT, KG 50,820

MANUFACTURER [TIMKEN](#)