

M255449TD/M255410 TIMKEN

Tapered roller bearings

TYPE: Roller bearings, Tapered, Double row, Type TDIIIT, double inner ring, tapered inner bore

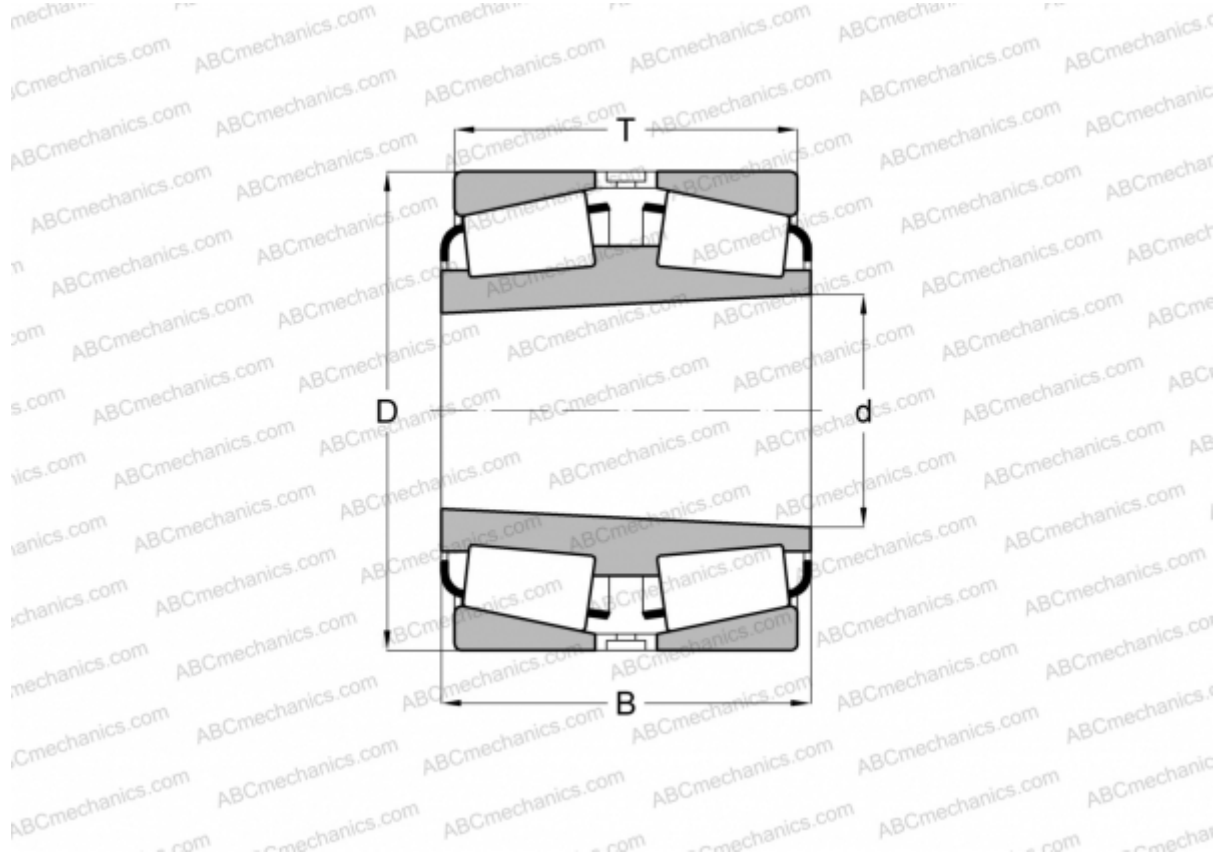

Technical specification

DIMENSIONS, MM

d	288,925
D	406,400
B	144,462
T	144,462

WEIGHT, KG 62,400

MANUFACTURER [TIMKEN](#)