

LM757043TD/LM757010 TIMKEN

Tapered roller bearings

TYPE: Roller bearings, Tapered, Double row, Type TDIIIT, double inner ring, tapered inner bore

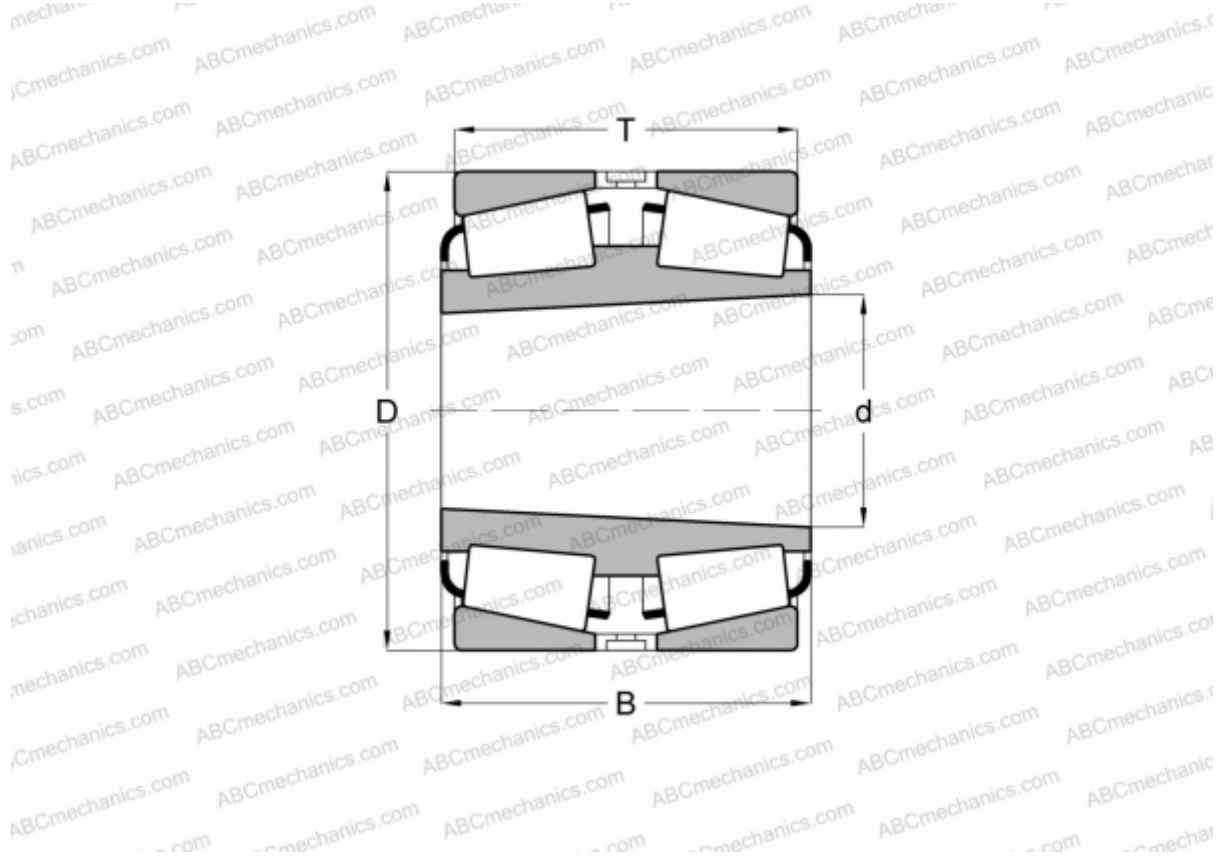

Technical specification

DIMENSIONS, MM

d	295,275
D	406,400
B	203,200
T	203,200

WEIGHT, KG 72,690

MANUFACTURER [TIMKEN](#)