

HM256846TD/HM256810 TIMKEN

Tapered roller bearings

TYPE: Roller bearings, Tapered, Double row, Type TDIIIT, double inner ring, tapered inner bore

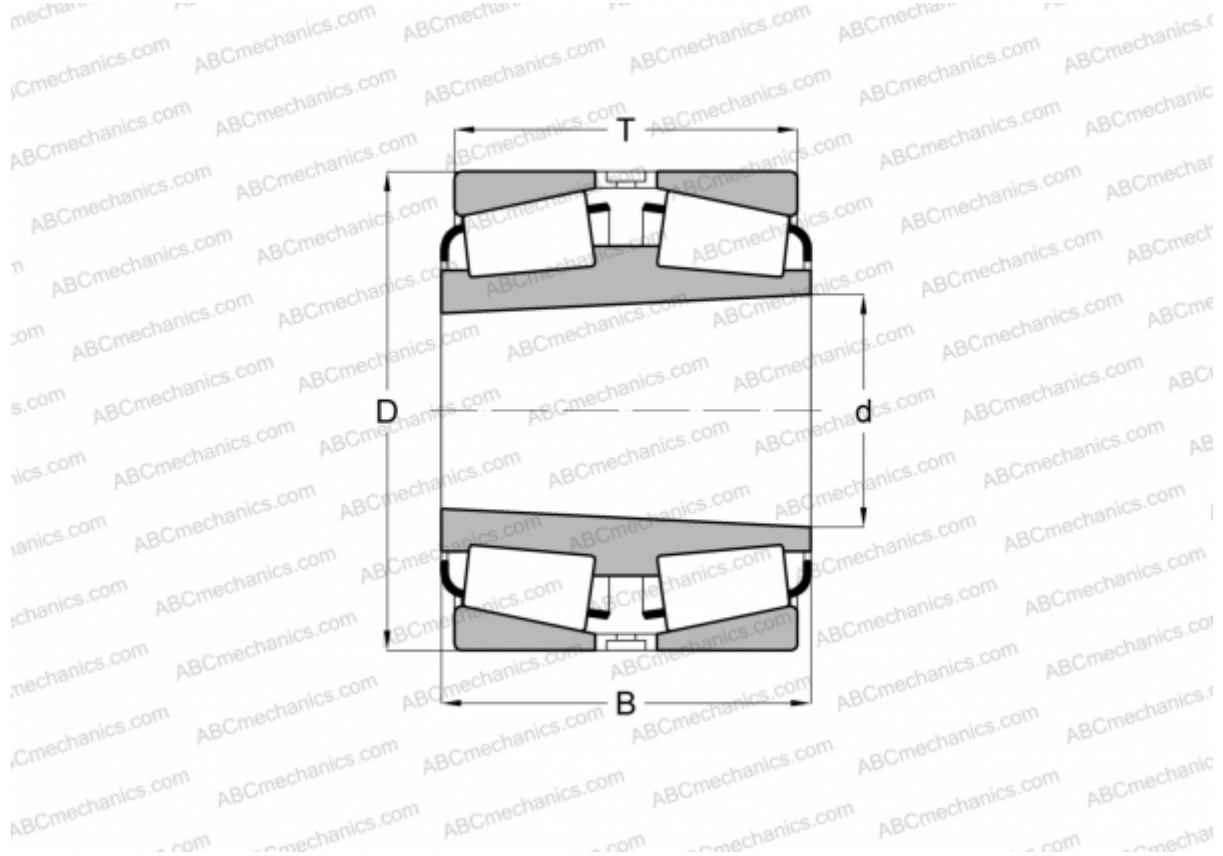

Technical specification

DIMENSIONS, MM

d	297,523
D	422,275
B	160,338
T	150,812

WEIGHT, KG 76,210

MANUFACTURER [TIMKEN](#)