

HM259045TD/HM259010 TIMKEN

Tapered roller bearings

TYPE: Roller bearings, Tapered, Double row, Type TDIIIT, double inner ring, tapered inner bore

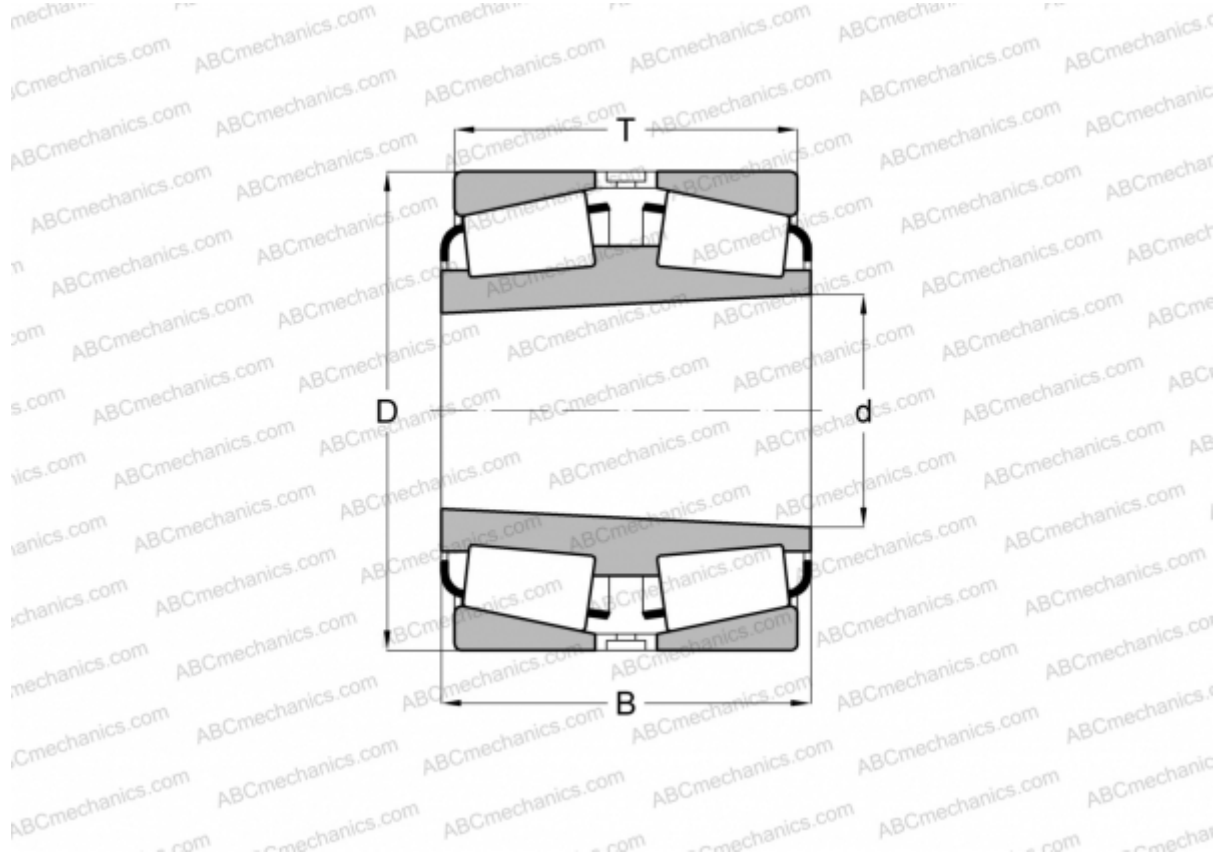

Technical specification

DIMENSIONS, MM

d	316,111
D	447,675
B	173,035
T	157,429

WEIGHT, KG 89,790

MANUFACTURER [TIMKEN](#)