

HM262749TD/HM262710 TIMKEN

Tapered roller bearings

TYPE: Roller bearings, Tapered, Double row, Type TDIIIT, double inner ring, tapered inner bore

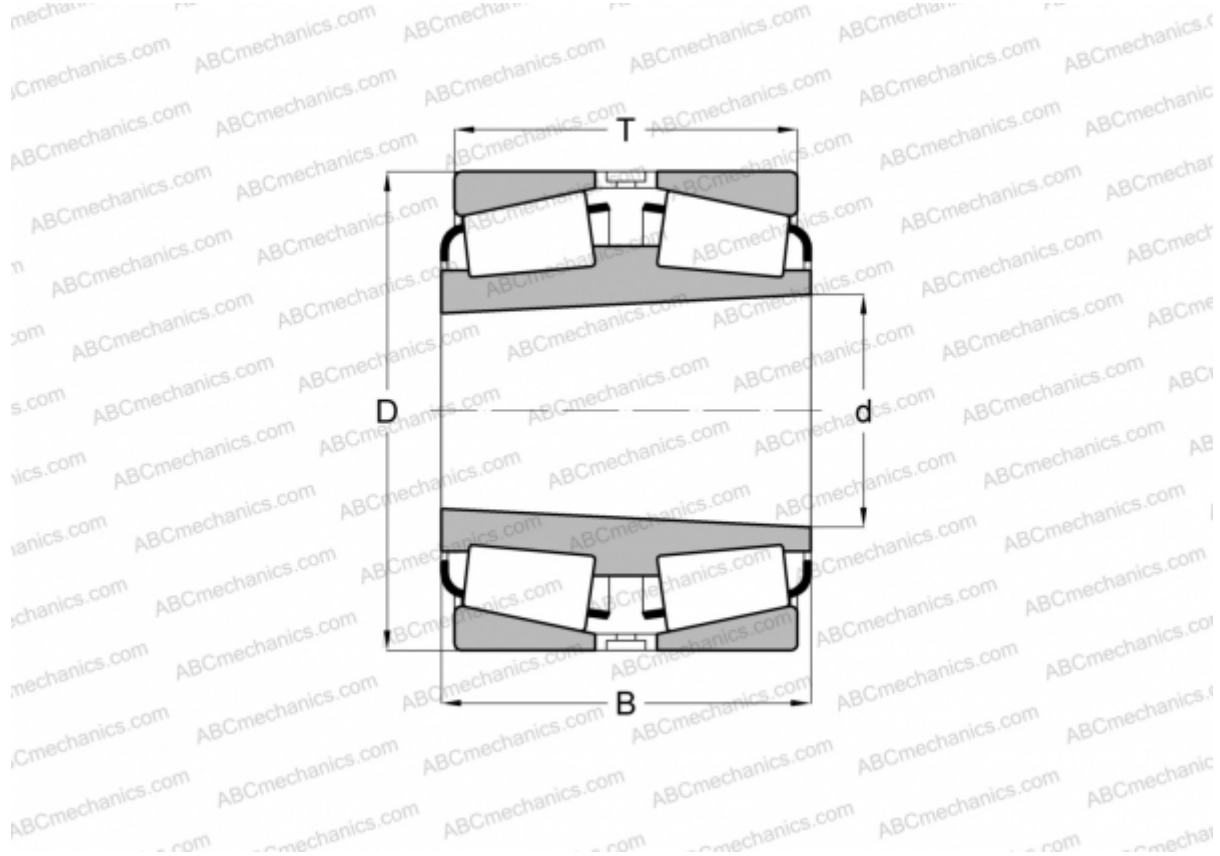

Technical specification

DIMENSIONS, MM

d	346,075
D	488,950
B	174,625
T	174,625

WEIGHT, KG 115,190

MANUFACTURER [TIMKEN](#)