

LM263145TD/LM263110 TIMKEN

Tapered roller bearings

TYPE: Roller bearings, Tapered, Double row, Type TDIIIT, double inner ring, tapered inner bore

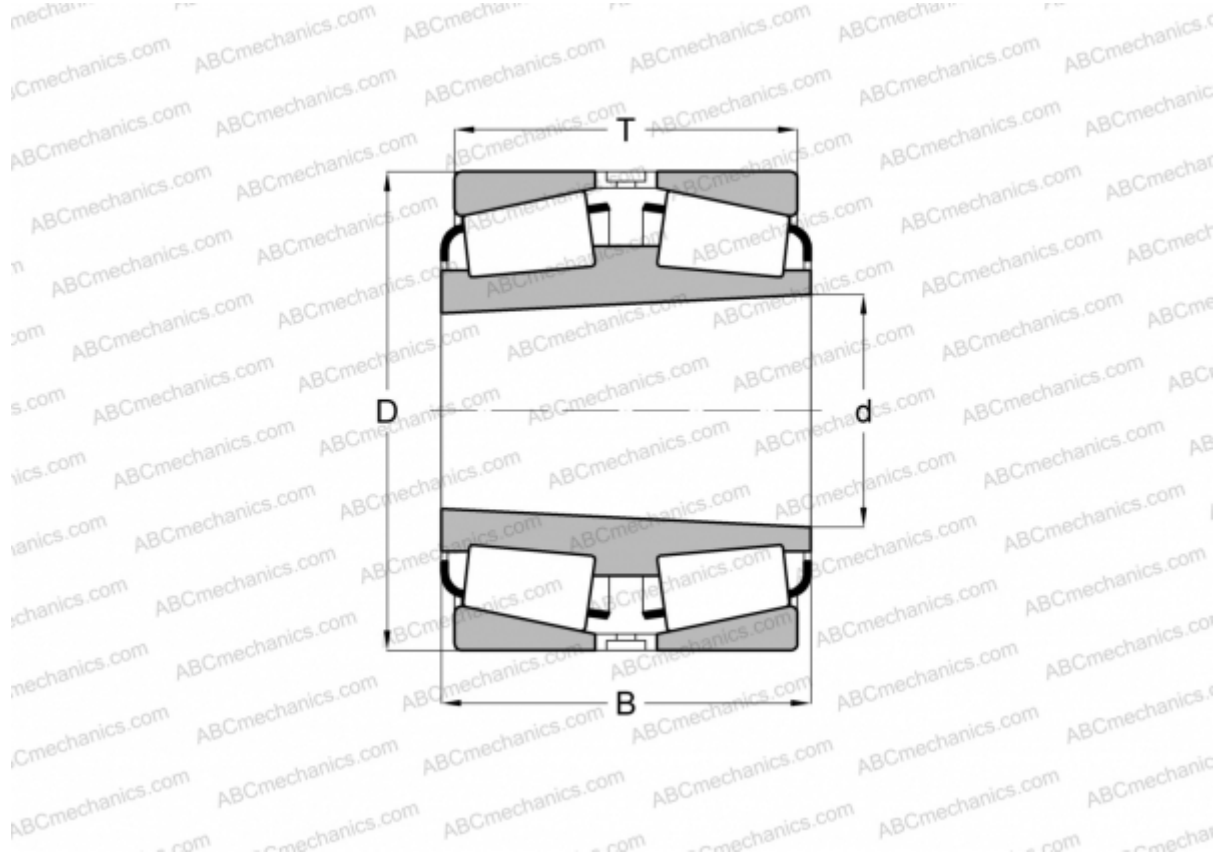

Technical specification

DIMENSIONS, MM

d	349,250
D	457,200
B	120,650
T	120,650

WEIGHT, KG 55,070

MANUFACTURER [TIMKEN](#)