

HM265049TD/HM265010 TIMKEN

Tapered roller bearings

TYPE: Roller bearings, Tapered, Double row, Type TDIIIT, double inner ring, tapered inner bore

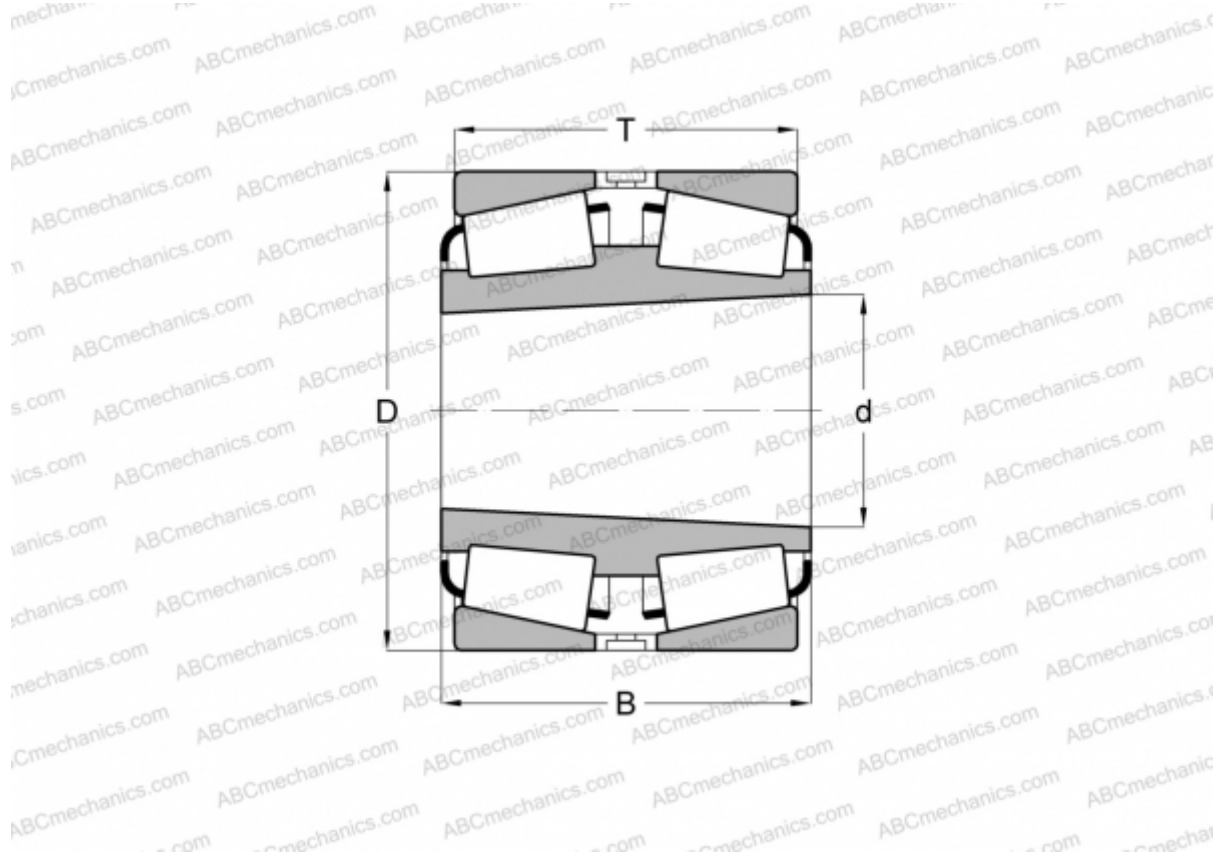

Technical specification

DIMENSIONS, MM

d	368,300
D	523,875
B	185,738
T	185,738

WEIGHT, KG 141,400

MANUFACTURER [TIMKEN](#)