

HM266449TD/HM266410 TIMKEN

Tapered roller bearings

TYPE: Roller bearings, Tapered, Double row, Type TDIIIT, double inner ring, tapered inner bore

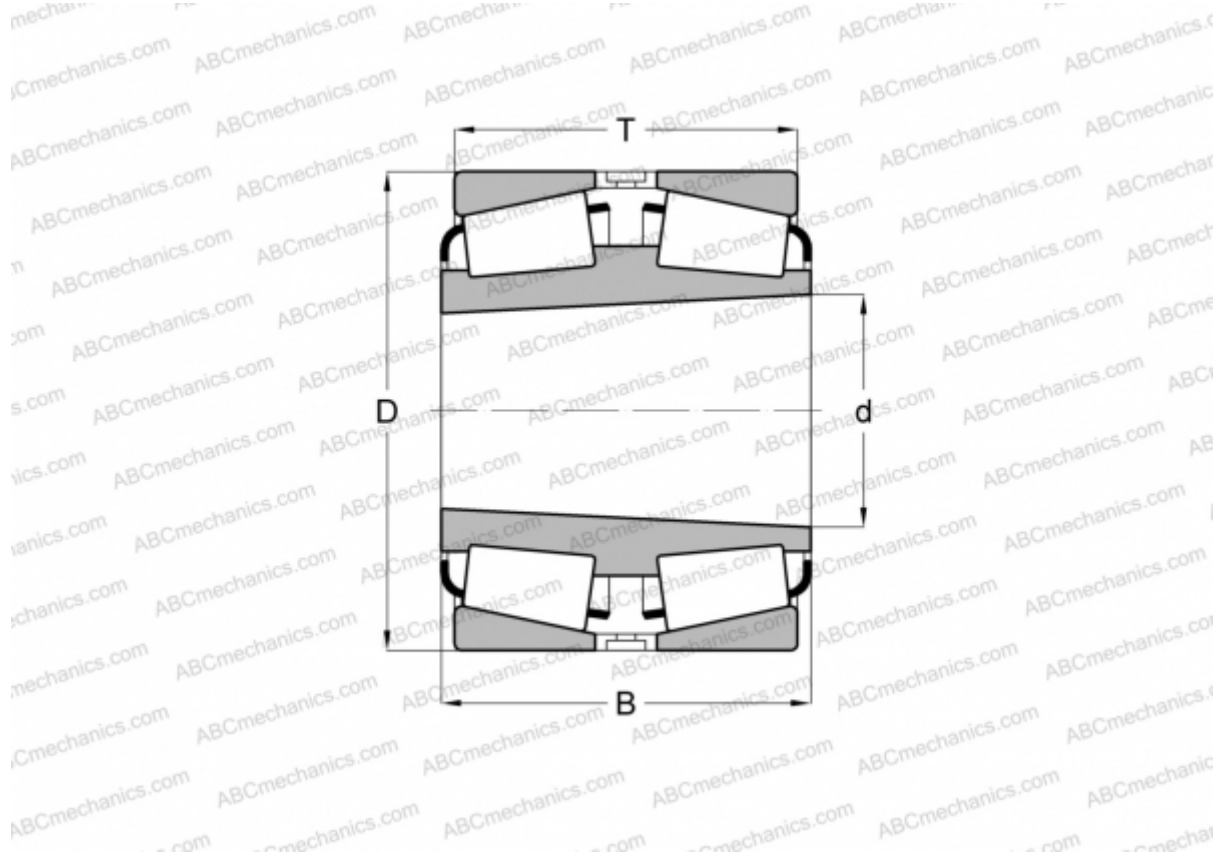

Technical specification

DIMENSIONS, MM

d	384,175
D	546,100
B	193,675
T	193,675

WEIGHT, KG 157,920

MANUFACTURER [TIMKEN](#)