

M270749TD/M270710 TIMKEN

Tapered roller bearings

TYPE: Roller bearings, Tapered, Double row, Type TDIIIT, double inner ring, tapered inner bore

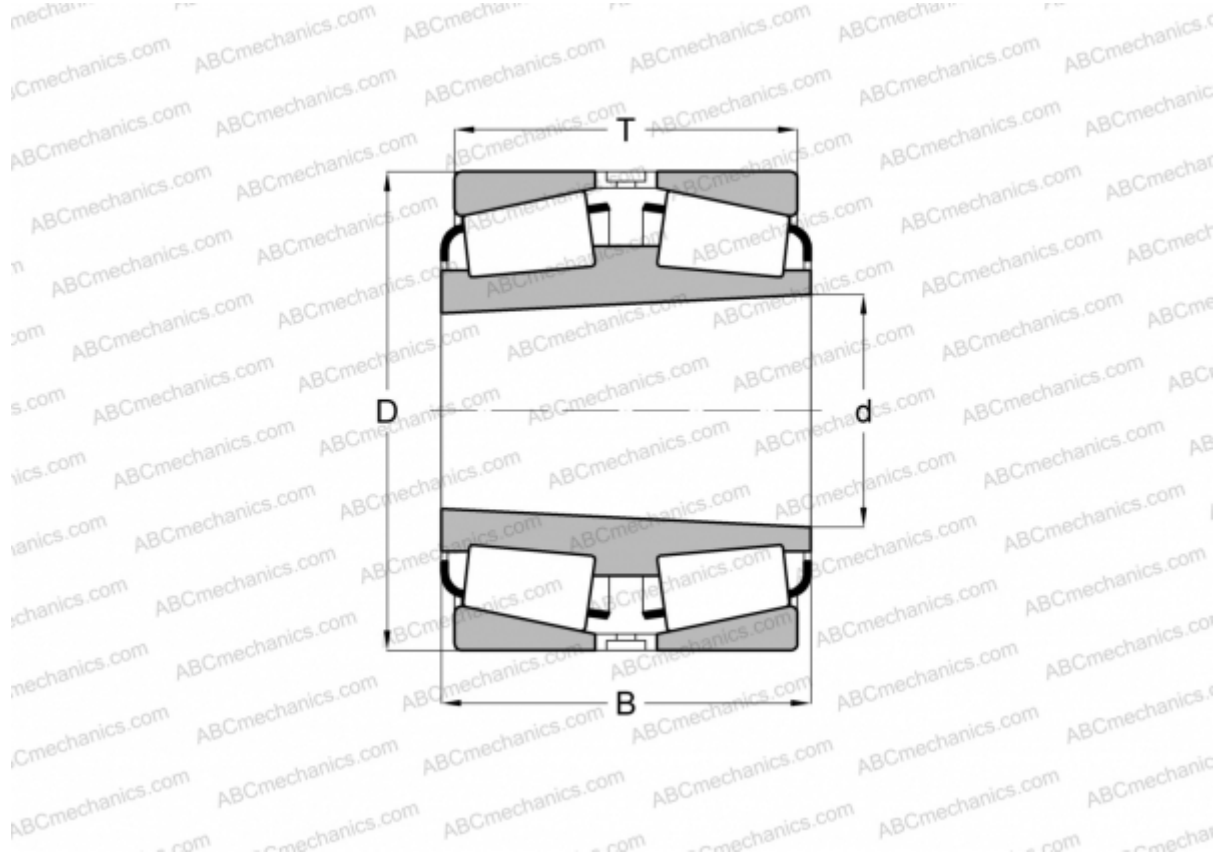

Technical specification

DIMENSIONS, MM

d	447,675
D	635,000
B	223,838
T	223,838

WEIGHT, KG 245,120

MANUFACTURER [TIMKEN](#)