

M274147TD/M274110 TIMKEN

Tapered roller bearings

TYPE: Roller bearings, Tapered, Double row, Type TDIIIT, double inner ring, tapered inner bore

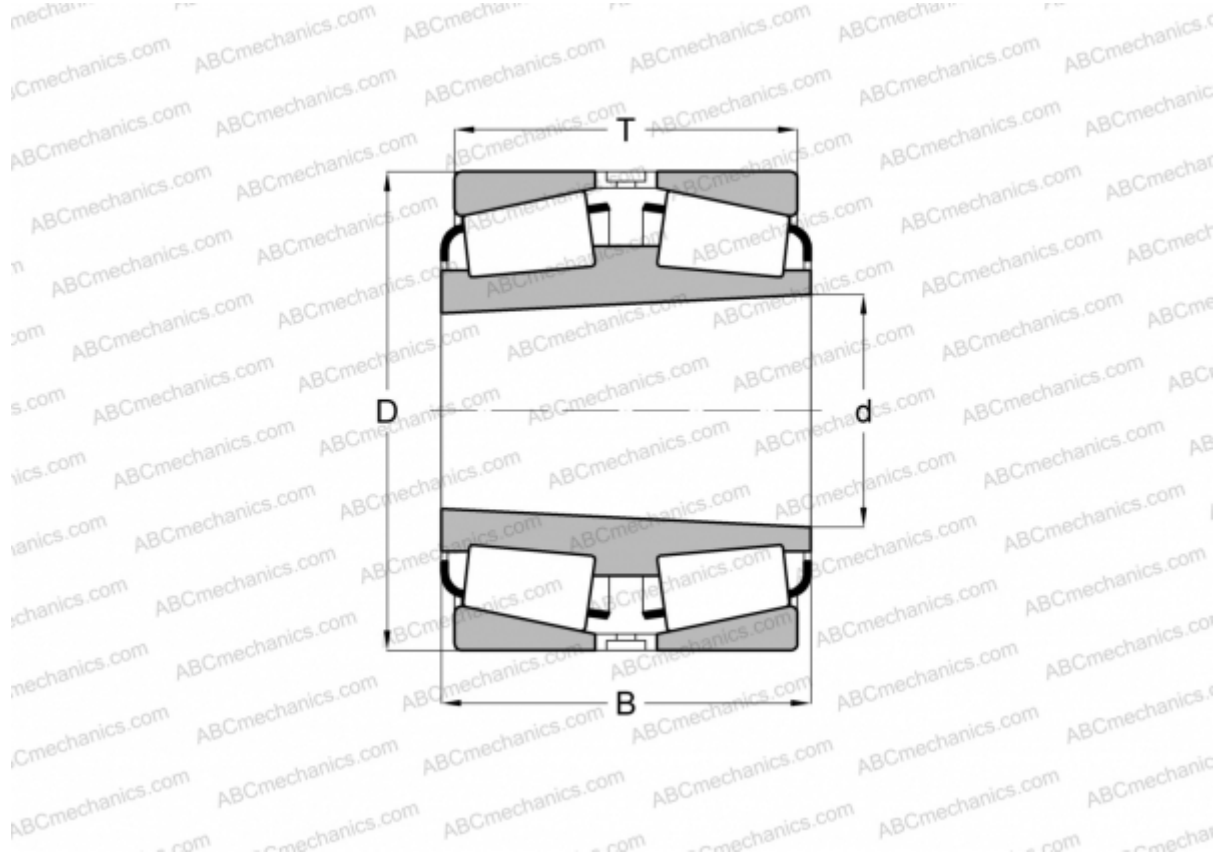

Technical specification

DIMENSIONS, MM

d	501,650
D	711,200
B	250,825
T	250,825

WEIGHT, KG 355,250

MANUFACTURER [TIMKEN](#)