

NA44156/44348D TIMKEN

Tapered roller bearings

TYPE: Roller bearings, Tapered, Double row, Type TNA, non-adjustable double-row bearing

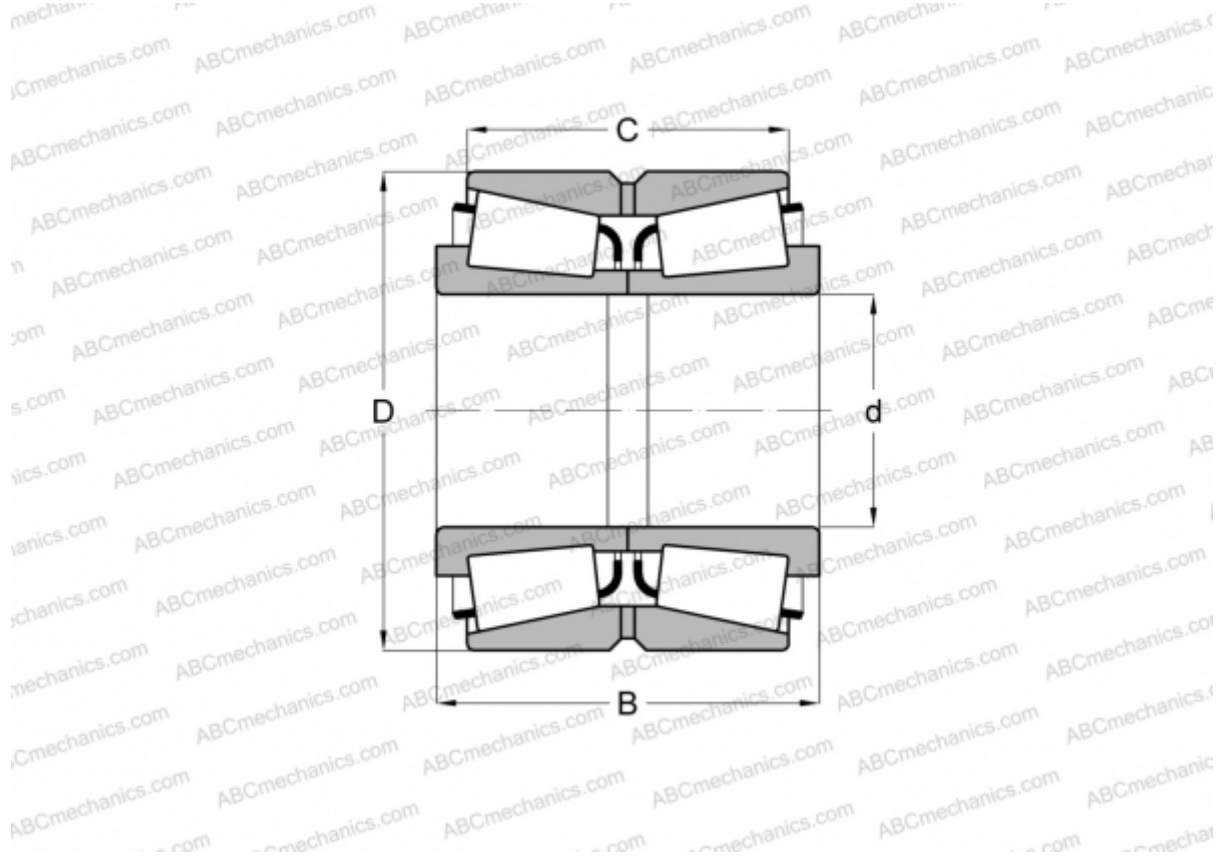

Technical specification

DIMENSIONS, MM

d	39,687
D	88,500
B	55,562
C	39,688

WEIGHT, KG 1,480

MANUFACTURER [TIMKEN](#)