

NA539/533D TIMKEN

Tapered roller bearings

TYPE: Roller bearings, Tapered, Double row, Type TNA, non-adjustable double-row bearing

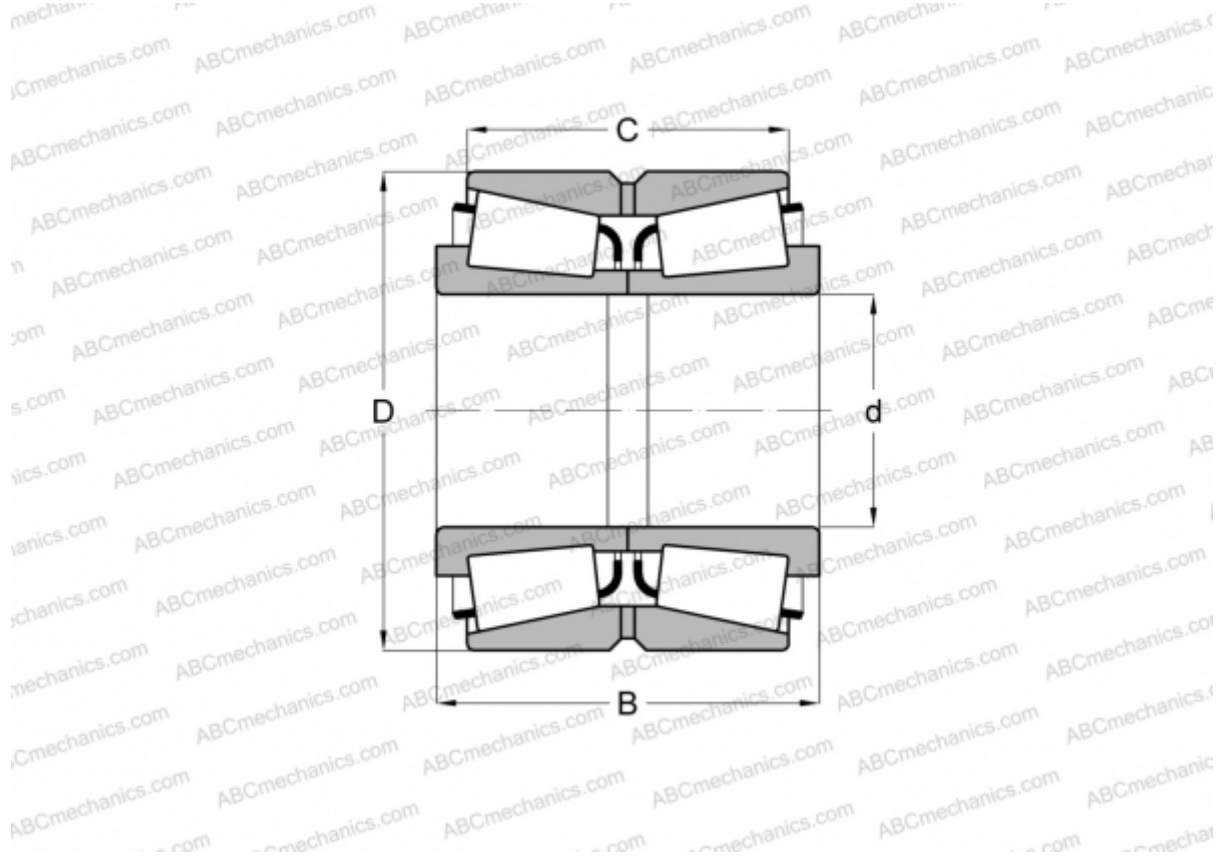

Technical specification

DIMENSIONS, MM

d	53,975
D	111,125
B	79,375
C	63,500

WEIGHT, KG 3,350

MANUFACTURER [TIMKEN](#)