

NA66212/66462D TIMKEN

Tapered roller bearings

TYPE: Roller bearings, Tapered, Double row, Type TNA, non-adjustable double-row bearing

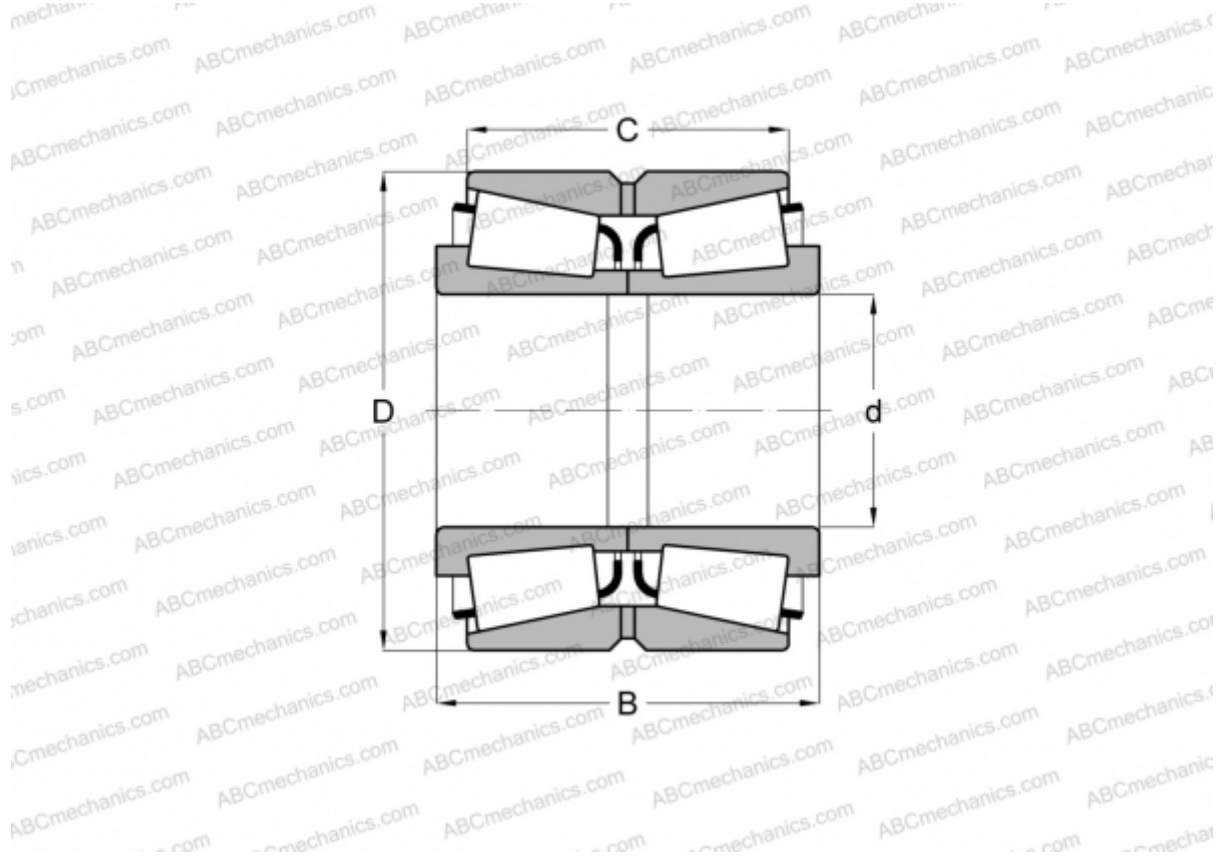

Technical specification

DIMENSIONS, MM

d	53,975
D	117,475
B	73,025
C	53,975

WEIGHT, KG 3,560

MANUFACTURER [TIMKEN](#)