

NA482/472D TIMKEN

Tapered roller bearings

TYPE: Roller bearings, Tapered, Double row, Type TNA, non-adjustable double-row bearing

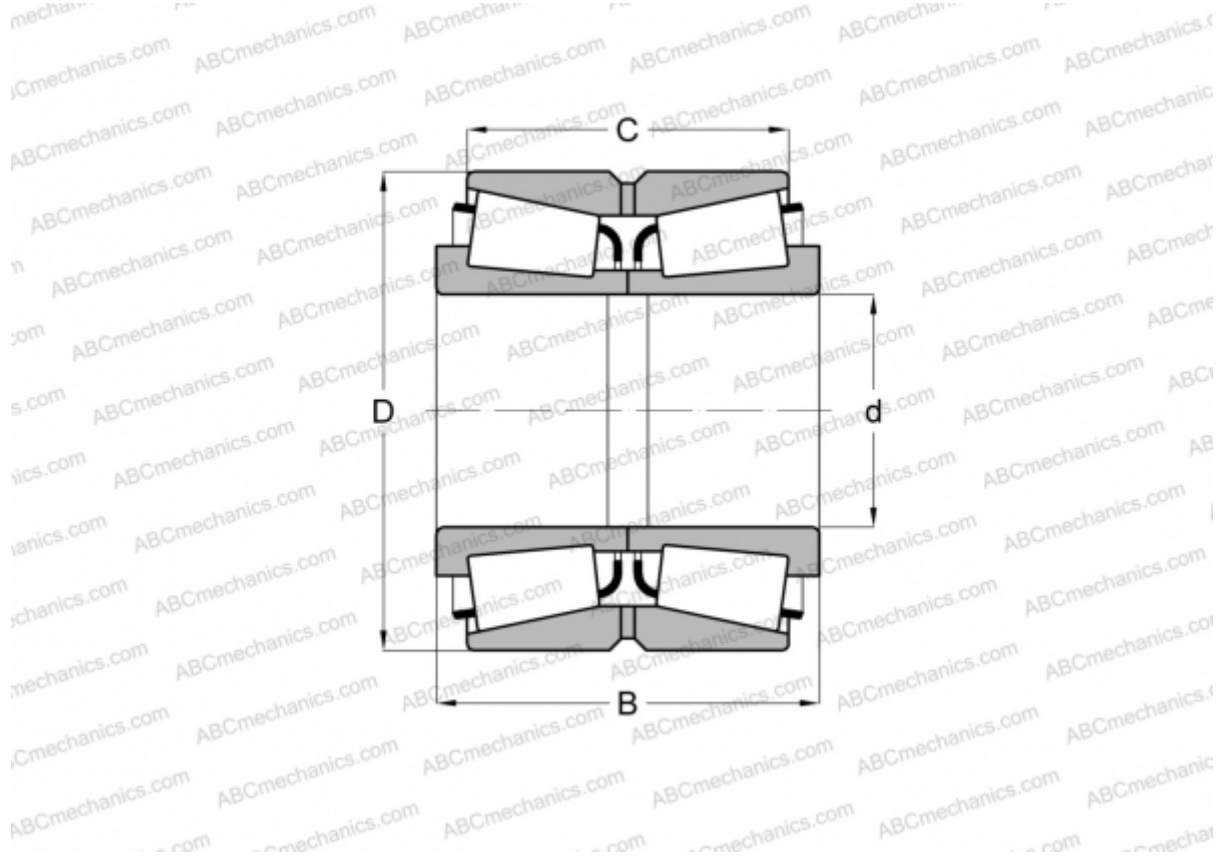

Technical specification

DIMENSIONS, MM

d	69,850
D	120,000
B	65,090
C	53,975

WEIGHT, KG 2,930

MANUFACTURER [TIMKEN](#)