

NA48385/48320D TIMKEN

Tapered roller bearings

TYPE: Roller bearings, Tapered, Double row, Type TNA, non-adjustable double-row bearing

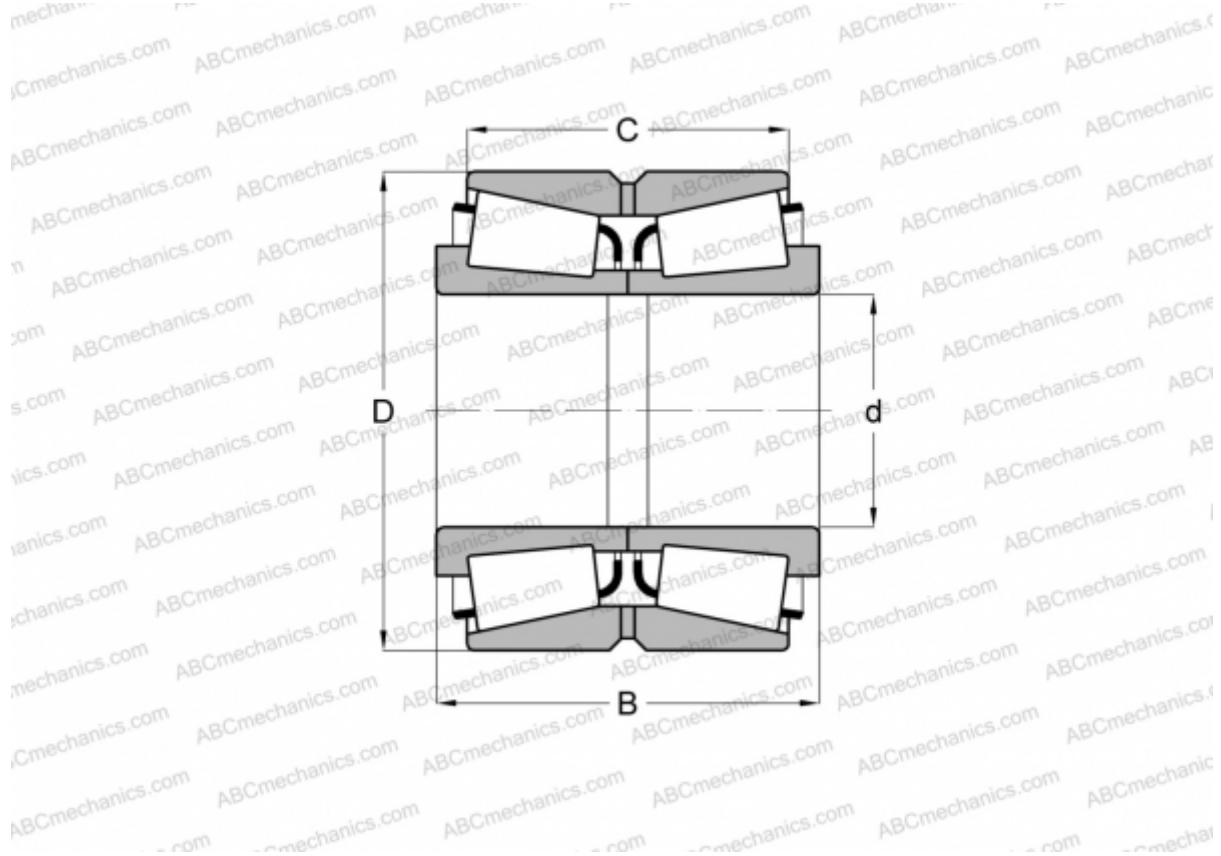

Technical specification

DIMENSIONS, MM

d	133,350
D	190,500
B	85,725
C	73,025

WEIGHT, KG 7,450

MANUFACTURER [TIMKEN](#)