

HM252348NA/HM252311D TIMKEN

Tapered roller bearings

TYPE: Roller bearings, Tapered, Double row, Type TNA, non-adjustable double-row bearing

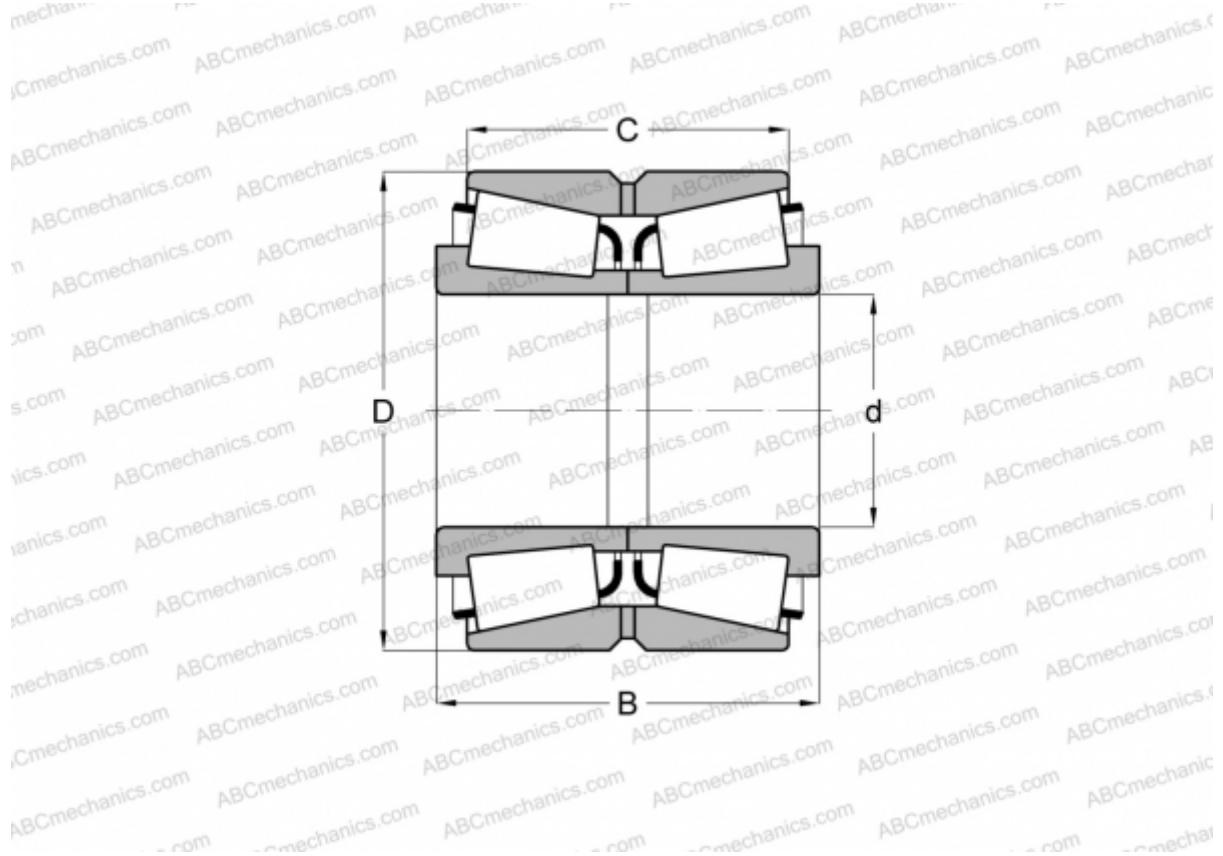

Technical specification

DIMENSIONS, MM

d	260,350
D	422,275
B	173,038
C	128,588

WEIGHT, KG 82,220

MANUFACTURER [TIMKEN](#)