

## 565920 FAG

Tapered roller bearings

TYPE: Roller bearings, Tapered, Double row, For loose fit on the roll neck, design 1 (FAG)

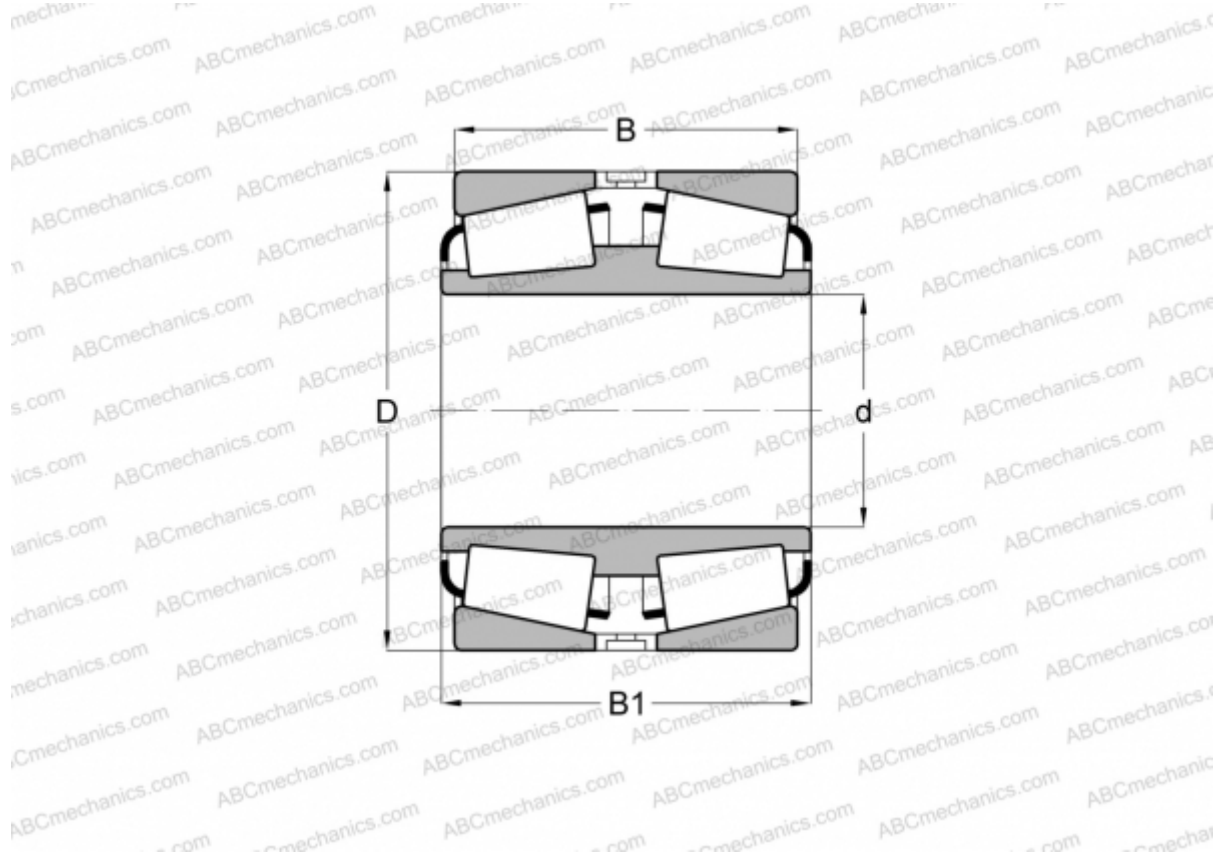

### Technical specification

#### DIMENSIONS, MM

d	220,663
D	314,325
B	115,888
B1	115,888

**WEIGHT, KG** 29,200

**MANUFACTURER** [FAG](#)

#### INTERCHANGE

TIMKEN [M244249DW.210](#)