

M244249DW.210 TIMKEN

Tapered roller bearings

TYPE: Roller bearings, Tapered, Double row, For loose fit on the roll neck, design 1 (FAG)

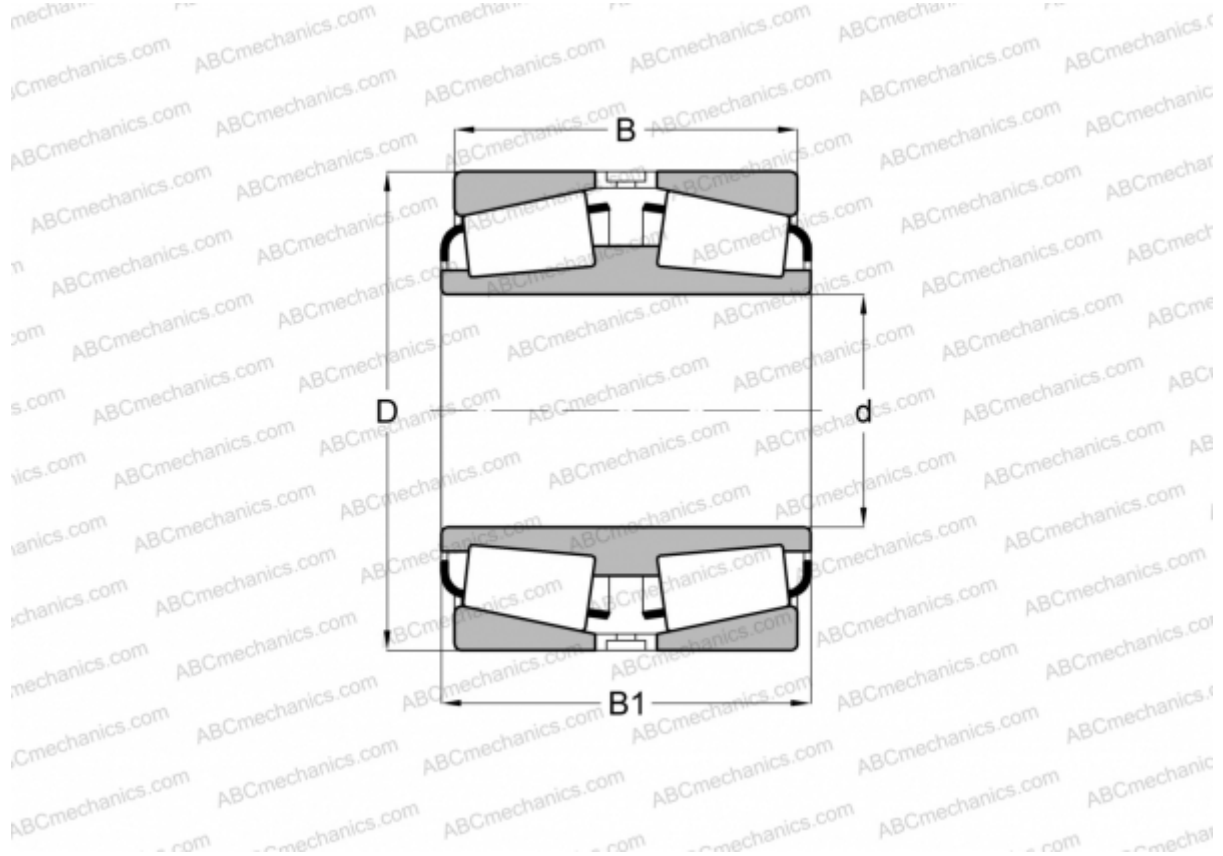

Technical specification

DIMENSIONS, MM

d	220,663
D	314,325
B	115,888
B1	115,888

WEIGHT, KG 29,200

MANUFACTURER [TIMKEN](#)

INTERCHANGE

FAG [565920](#)