

EE822101DW.175 TIMKEN

Tapered roller bearings

TYPE: Roller bearings, Tapered, Double row, For loose fit on the roll neck, design 1 (FAG)

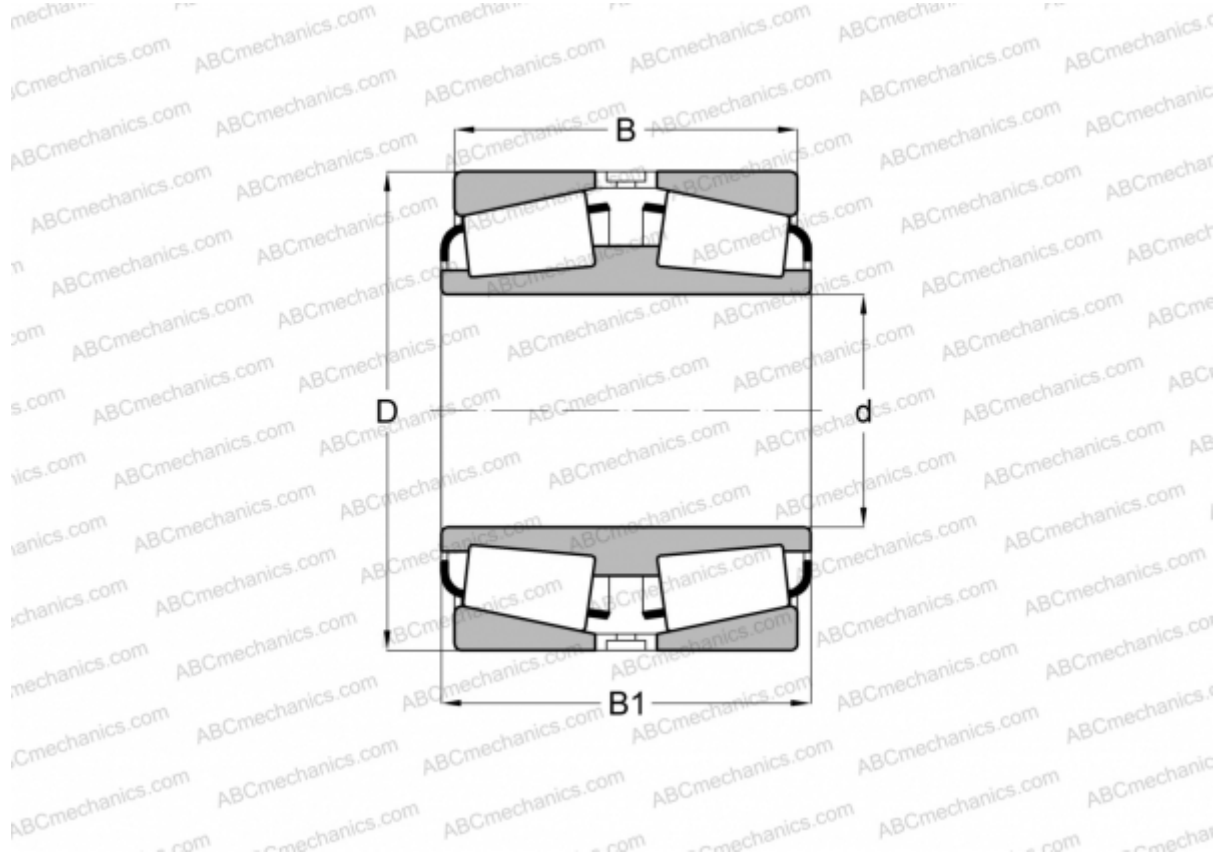

Technical specification

DIMENSIONS, MM

d	254,000
D	444,500
B	133,350
B1	133,350

WEIGHT, KG 89,700

MANUFACTURER [TIMKEN](#)

INTERCHANGE

FAG [505684](#)