

546348 FAG

Tapered roller bearings

TYPE: Roller bearings, Tapered, Double row, For loose fit on the roll neck, design 1 (FAG)

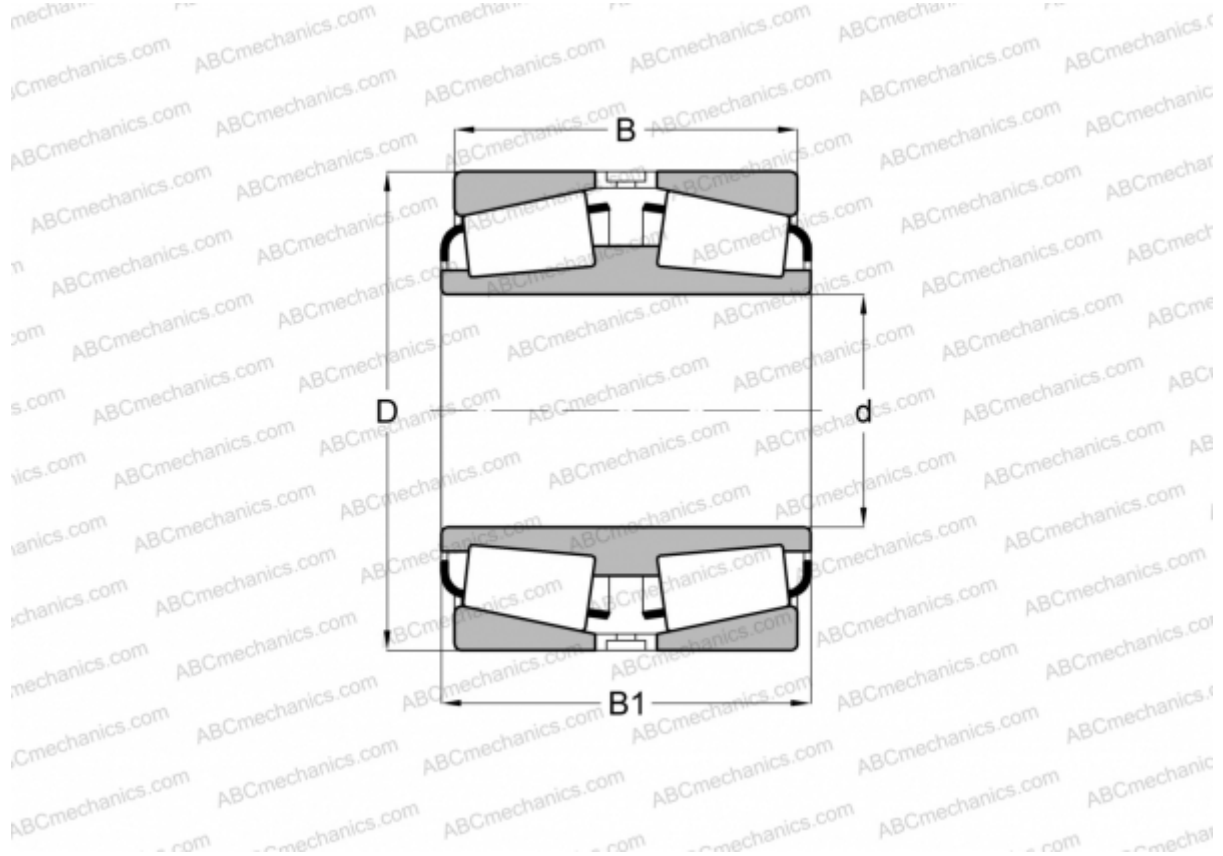

Technical specification

DIMENSIONS, MM

d	288,925
D	406,400
B	144,462
B1	144,462

WEIGHT, KG 59,500

MANUFACTURER [FAG](#)

INTERCHANGE

TIMKEN [M255449DW.410](#)