

HM256849DW.810 TIMKEN

Tapered roller bearings

TYPE: Roller bearings, Tapered, Double row, For loose fit on the roll neck, design 1 (FAG)

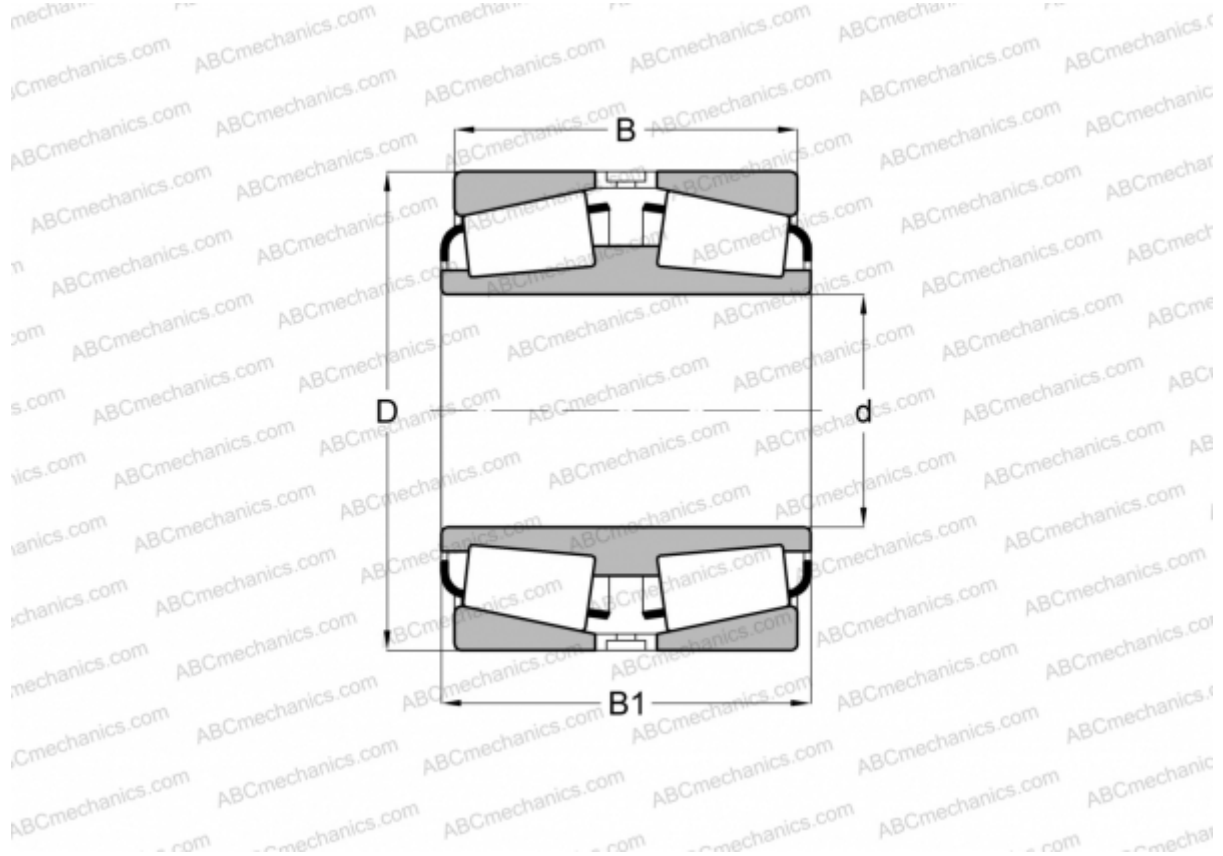

Technical specification

DIMENSIONS, MM

d	300,038
D	422,275
B	150,813
B1	150,813

WEIGHT, KG 67,800

MANUFACTURER [TIMKEN](#)

INTERCHANGE

FAG [542664](#)