

572151 FAG

Tapered roller bearings

TYPE: Roller bearings, Tapered, Double row, For loose fit on the roll neck, design 1 (FAG)

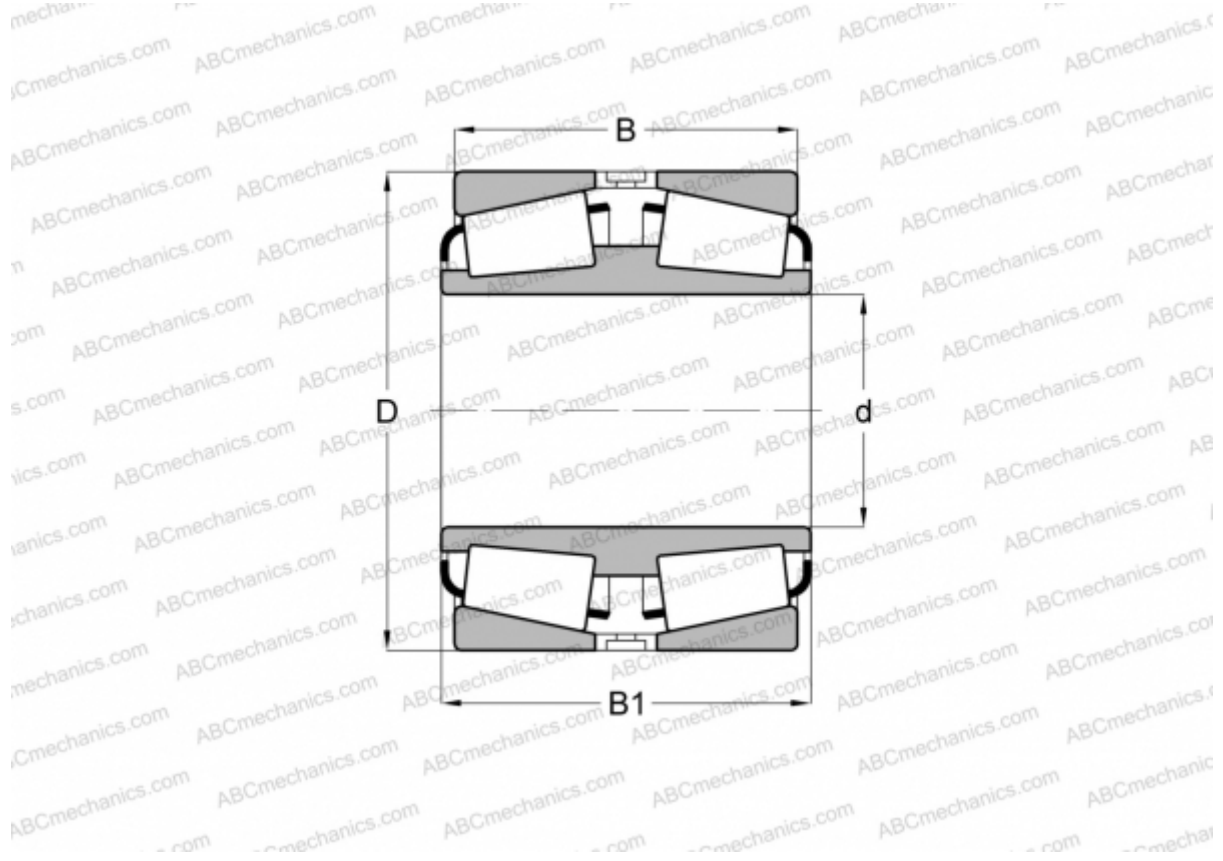

Technical specification

DIMENSIONS, MM

d	304,800
D	419,100
B	130,175
B1	130,175

WEIGHT, KG 55,200

MANUFACTURER [FAG](#)

INTERCHANGE

TIMKEN [M257149DW.110](#)