

515956 FAG

Tapered roller bearings

TYPE: Roller bearings, Tapered, Double row, For loose fit on the roll neck, design 1 (FAG)

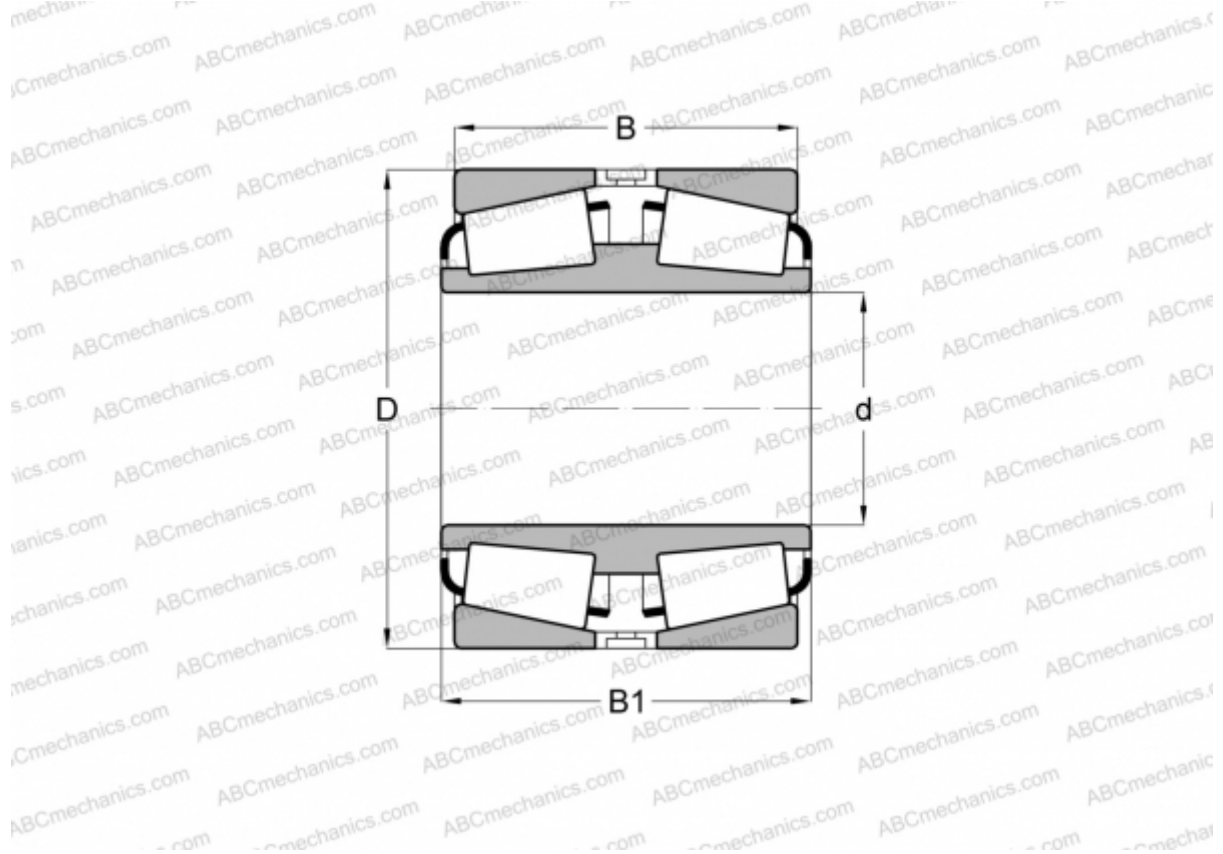

Technical specification

DIMENSIONS, MM

d	342,900
D	533,400
B	139,690
B1	146,050

WEIGHT, KG 112,000

MANUFACTURER [FAG](#)

INTERCHANGE

TIMKEN [EE971355DW.100](#)