

528949 FAG

Tapered roller bearings

TYPE: Roller bearings, Tapered, Double row, For loose fit on the roll neck, design 1 (FAG)

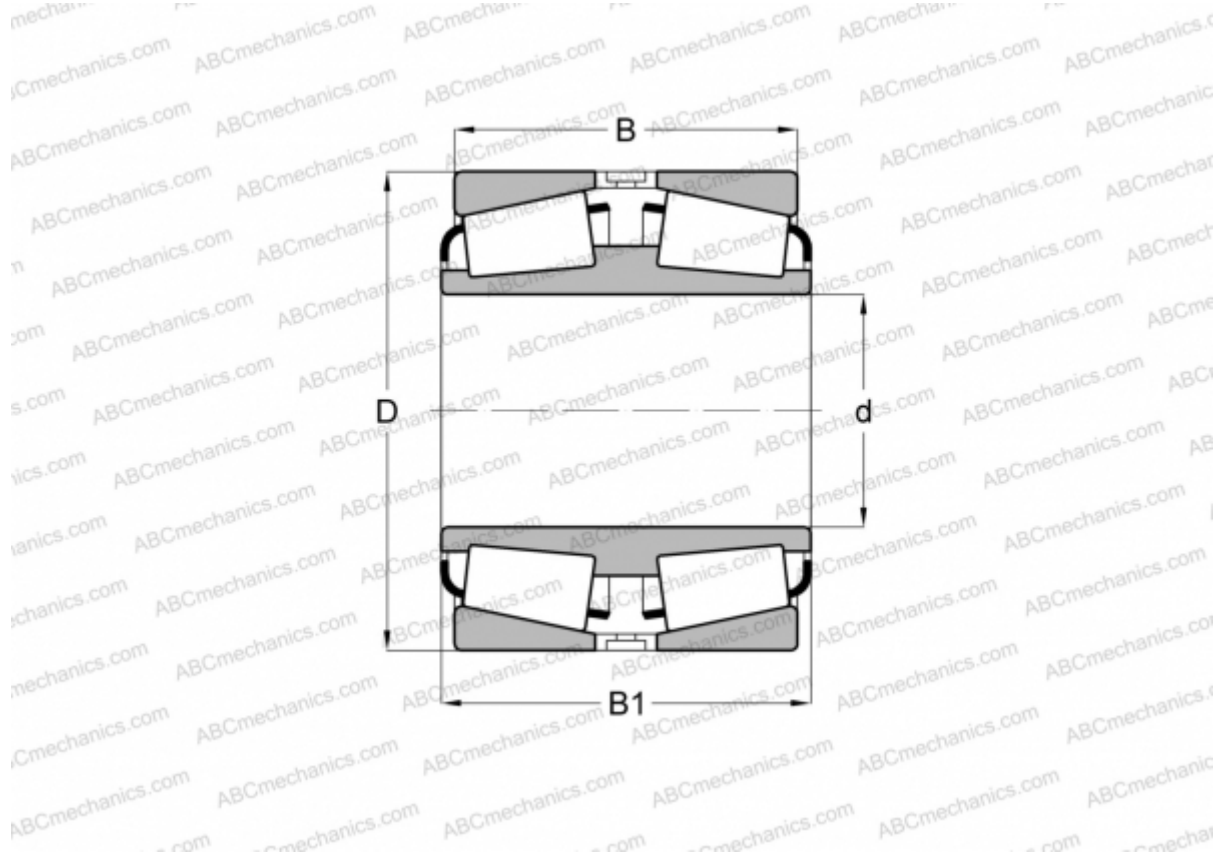

Technical specification

DIMENSIONS, MM

d	431,902
D	685,698
B	330,200
B1	330,200

WEIGHT, KG 474,000

MANUFACTURER [FAG](#)

INTERCHANGE

TIMKEN [EE650171D.270](#)