

538086 FAG

Tapered roller bearings

TYPE: Roller bearings, Tapered, Double row, For loose fit on the roll neck, design 1 (FAG)

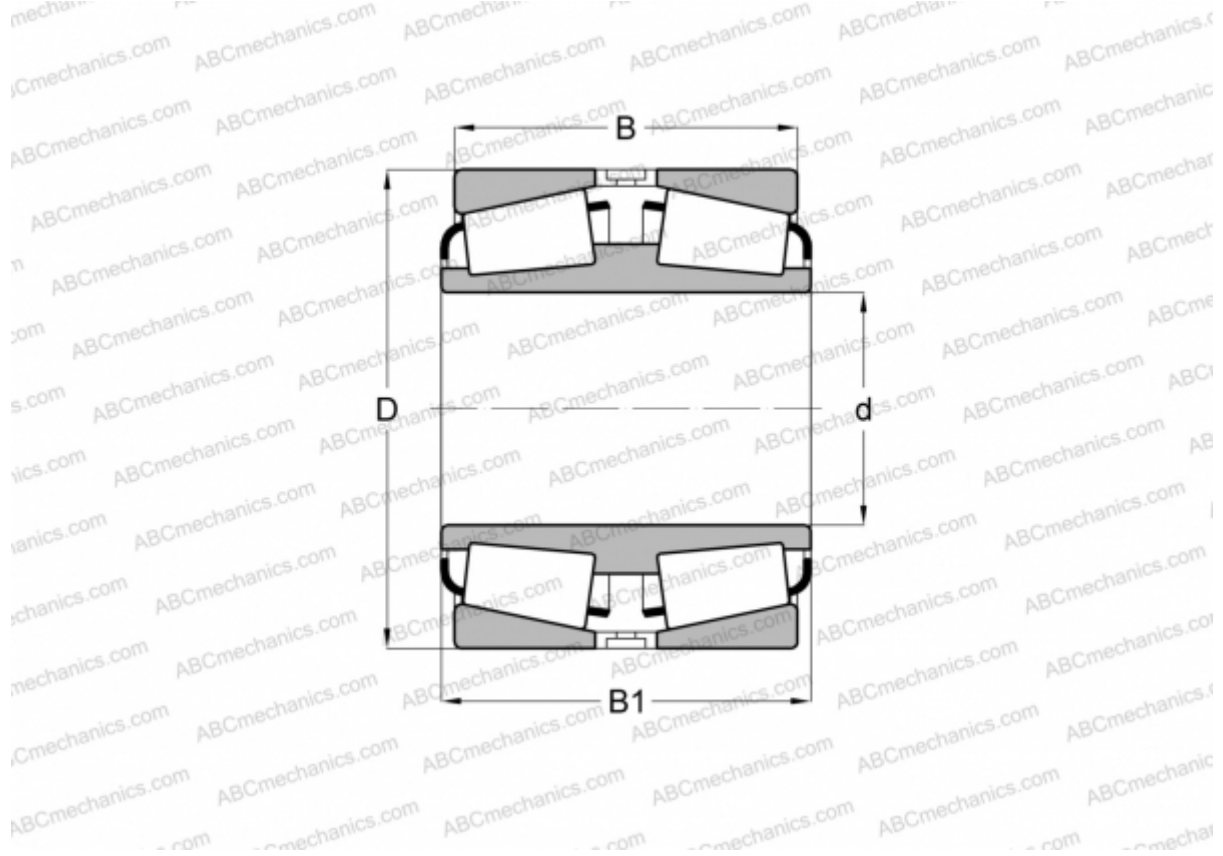

Technical specification

DIMENSIONS, MM

d	609,600
D	820,000
B	171,450
B1	171,450

WEIGHT, KG 267,000

MANUFACTURER [FAG](#)