

800501 FAG

Tapered roller bearings

TYPE: Roller bearings, Tapered, Double row, For loose fit on the roll neck, design 3 (FAG)

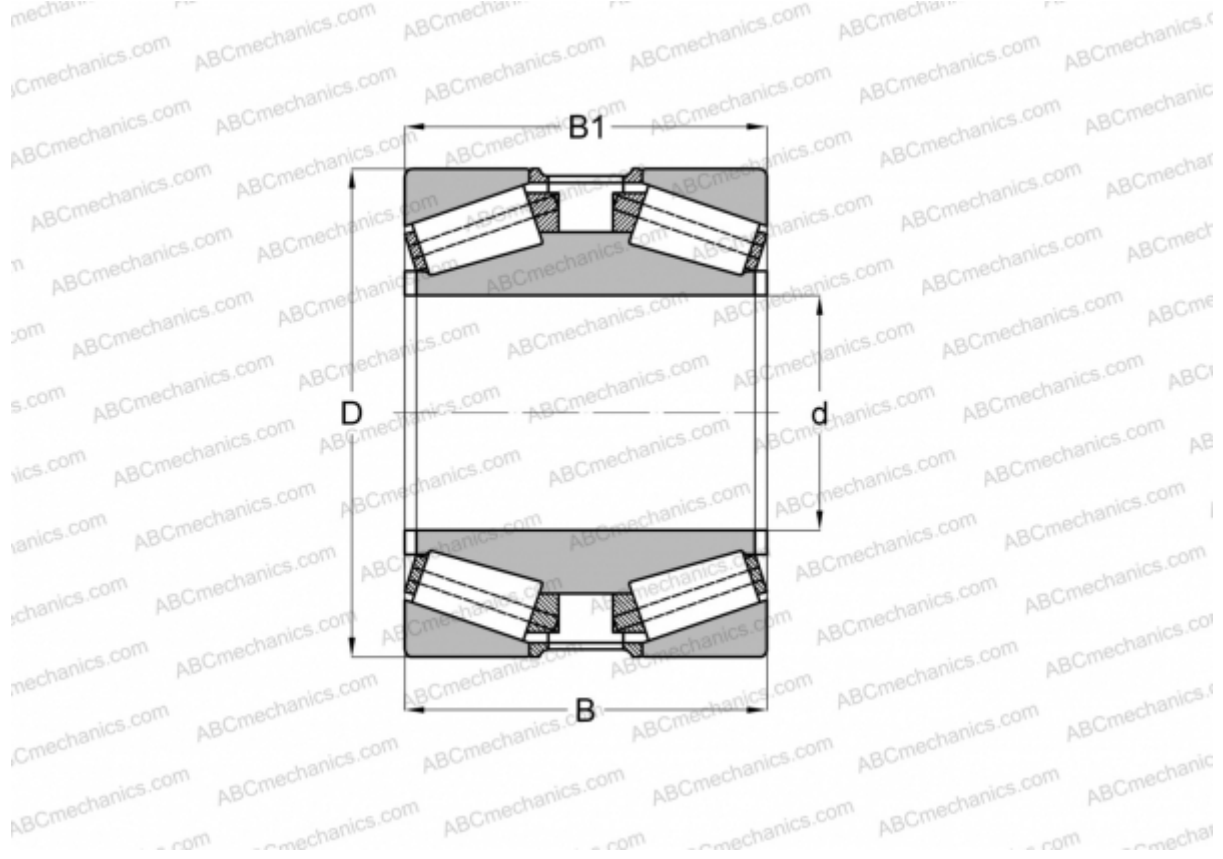

Technical specification

DIMENSIONS, MM

d	635,000
D	939,800
B	304,800
B1	304,800

WEIGHT, KG 753,000

MANUFACTURER [FAG](#)