

M282249DW.210 TIMKEN

Tapered roller bearings

TYPE: Roller bearings, Tapered, Double row, For loose fit on the roll neck, design 3 (FAG)

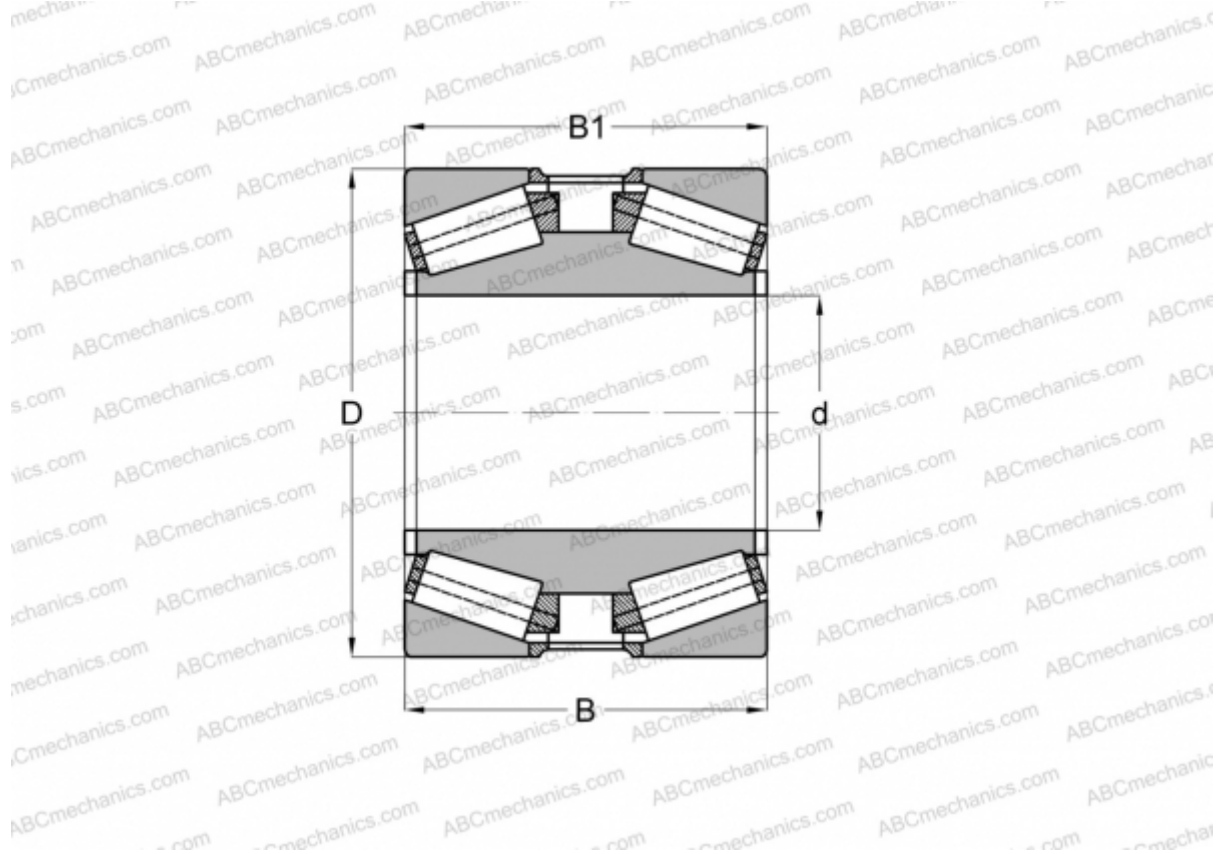

Technical specification

DIMENSIONS, MM

d	682,625
D	965,200
B	338,138
B1	338,138

WEIGHT, KG 800,000

MANUFACTURER [TIMKEN](#)

INTERCHANGE

FAG [568023](#)