

## 532828 FAG

Tapered roller bearings

TYPE: Roller bearings, Tapered, Double row, For loose fit on the roll neck, design 3 (FAG)

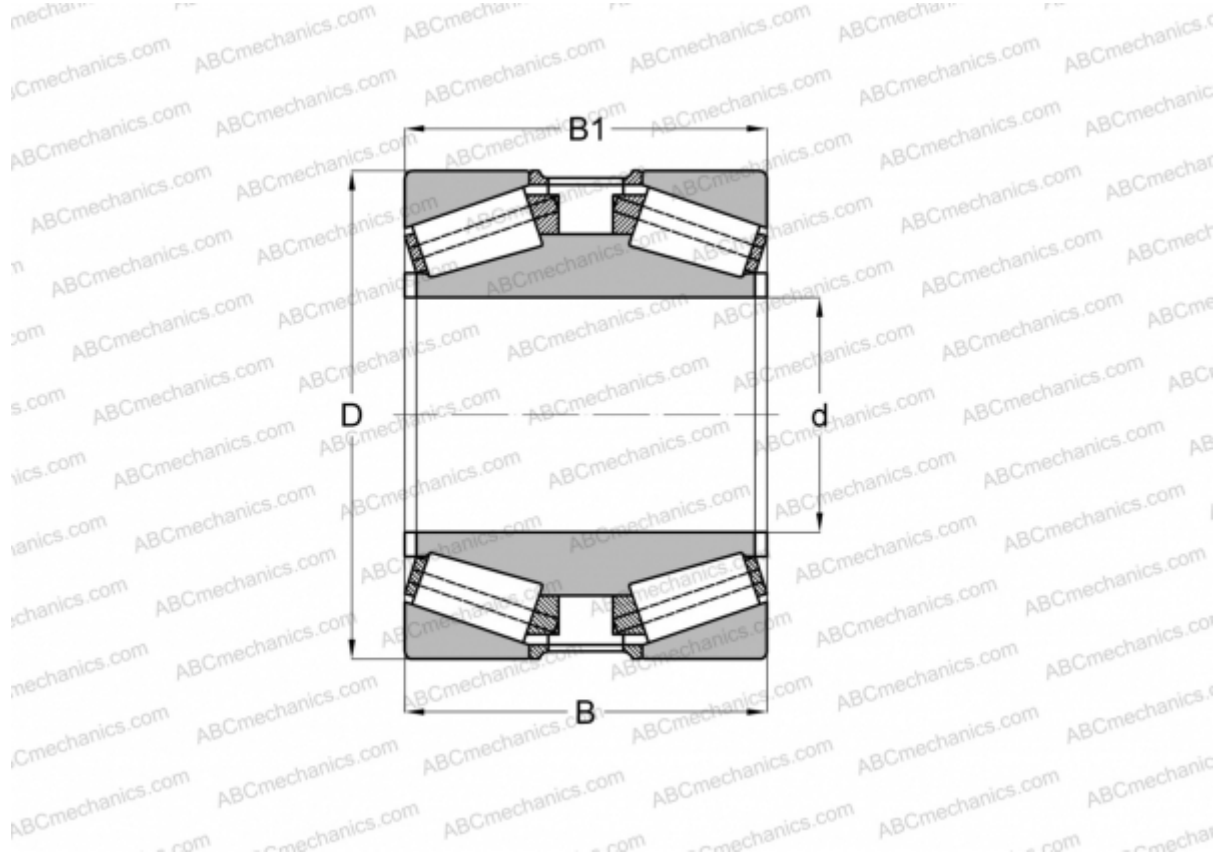

### Technical specification

#### DIMENSIONS, MM

d	710,000
D	900,000
B	197,000
B1	197,000

**WEIGHT, KG** 320,000

**MANUFACTURER** [FAG](#)